



Xpass S2

Intelligent IP Access Control Reader

Installation Guide

EN 101.00.XPS2 V1.11

Important Safety Information

Carefully review the information within the user manual before installing or operating the device. Pay careful attention to the warning and cautions below as they are here to prevent any risk or damage to any person(s) or property associated with the device.



Warning

Failure to heed these warnings may lead to serious injury or even death!

Installation

- Do not install the device near heat sources such as radiators, heat registers, and stoves.
- Do not install the device near areas of large electromagnetic interference.

Usage

- Do not disassemble, repair or reconstruct the device. Disassembling the device will void the warranty.
- Only use the device its intended use. Contact your nearest Suprema dealer for technical support.



Caution

Failure to heed these cautions may lead to minor injury or damage the device.

Installation

- Do not leave cables (especially power cables) exposed to the outer environment.
- Do not install the device near objects with a strong magnetic field such as magnets, computer monitors (especially CRT), TV screens and speakers.
- Use a separate power supply for Secure I/O 2, electric lock and Xpass S2 respectively. If connecting and using the power supply to these devices together, the devices may malfunction.

Usage

- Do not drop or apply any physical shock/impact to the device.
- Regularly clean the product with a soft dry cloth; avoid benzene or alcohol.

Contents

Product Components	4
Optional Accessories	5
Name of Each Part	6
LED Status	7
Reset Network Settings	8
Product Dimension	9
Cables and Connectors	10
Power Connection	11
LAN Connection	12
RS485 Connection	14
Relay Connection	16
Digital Input Connection	19
Wiegand Input/Output	21
Installation of Wall-mount Bracket	22
Installation of Extended Bracket	23
Installation Reference	24
Specification	27
Electrical Specification	28
FCC Rules	29

Product Components

- **Basic Components**

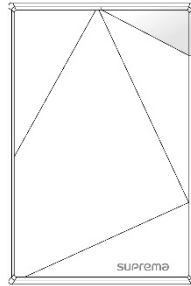

Xpass S2

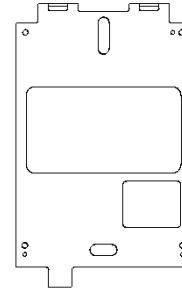

Wall Bracket



**Wall Mounting Screws
(2 ea)**



**Screw Anchors
(2 ea)**



Shrinkable Tubes

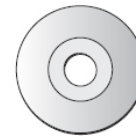

Software CD



**Diode
(1 ea)**

Optional Accessories

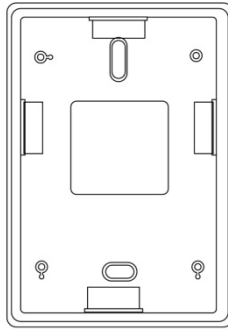

Extended Bracket

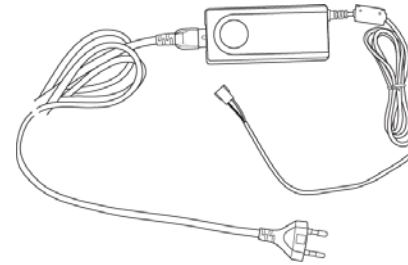

12VDC Adaptor



Secure I/O

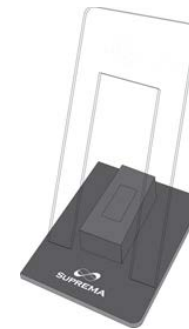

Plastic Stand

Name of Each Part

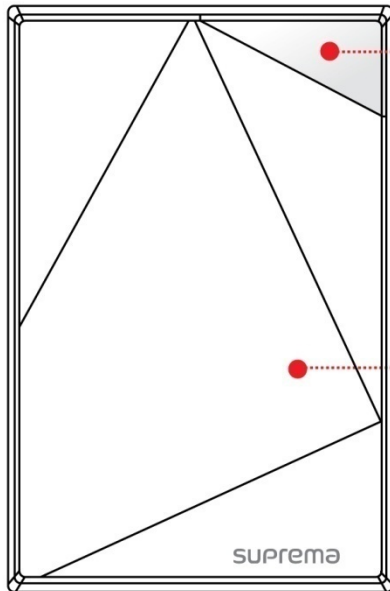

LED

Displays the current status with various colors.

Network Reset Button

When malfunction occurs, if you press this button it is initialized as factory default.

RFID Reading area

Recognizes a card placed over the area.

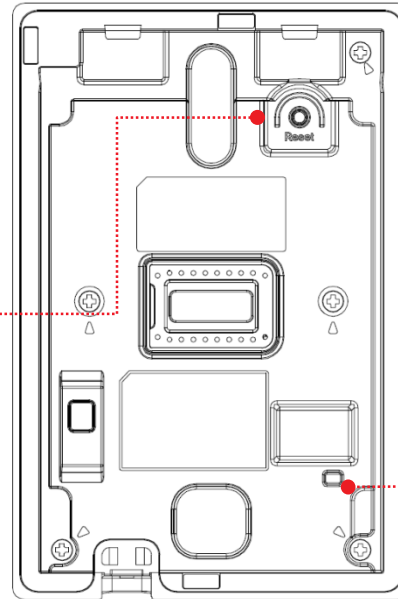

Fixing screw

Adjusts between main body and bracket screw.

TCP/IP Status LED

Displays TCP/IP connection status

LED Status

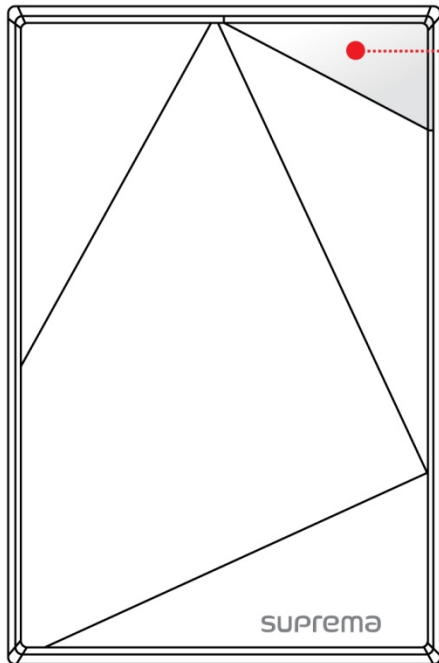

LED Status by Color

Color	Sound	Description
Green	Beep x 3	Authorization Success
Red	Long Beep	Authorization Fail
Pink	Short Beep	On Processing
Flicker Blue/Skyblue Color per 2 sec	N/A	Normal
Flicker Red/Pink Color per 2 sec	N/A	Locked
Flicker Blue/Red Color per 2 sec	N/A	Initialized Time due to the Internal Battery Discharge
Flicker Blue/Yellow Color per 2 sec	N/A	IP address is not assigned when terminal is set as Use in the DHCP of TCP/IP setting
For first operation, red LED is blinking by every 2 seconds.	N/A	Failed. Please contact to your distributor or Suprema
For normal operation, red LED is blinking by every 2 seconds.	N/A	Security Status
Yellow LED is blinking shortly.	N/A	Terminal is used or received a packet to get IP address when terminal is set as Use in the Idle status or TCP/IP Setting

Reset Network Settings

When you install the Xpass S2 or forget the network setting's value of Xpass S2 in use, can initial the network setting's value (TCP/IP address, RS-485 setting) in the switch of Xpass S2's back side as follows;

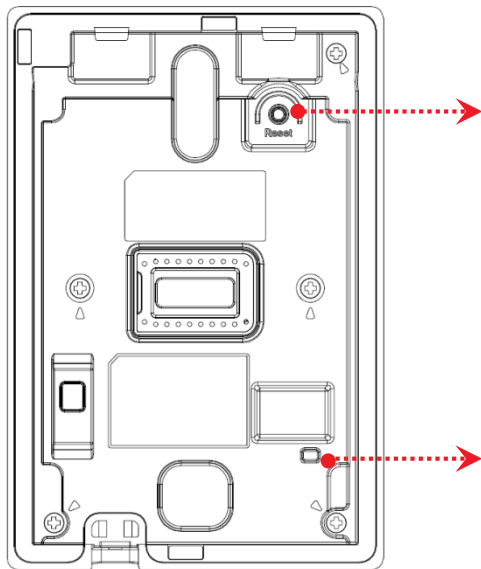

Reset Network Settings

1. Press the Reset button located on the rear of the Xpass S2 for 3 seconds or more.
2. Use the BioStar (Ver. 1.8 or higher) to connect to the Xpass S2 using the default settings.

Default Network Settings:

- IP Address (Static): 192.168.0.1
- Use Server: Disabled
- RS485: PC Connection, 115200bps

3. Enter the desired IP address or RS485 settings and save the new settings.
4. Remove the Xpass S2 from the device list and reconnect to the device using the new network settings.

TCP/IP Status LED

- Green LED blinks shortly: Displaying connection status by TCP/IP
- Red LED blinks shortly: Displaying data transfer status by TCP/IP

Product Dimension

(unit: mm)

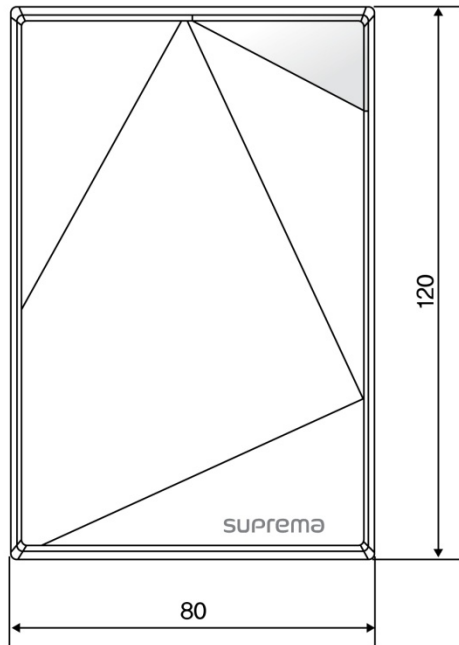

< Front View >

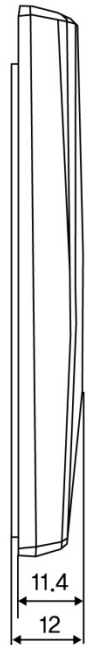

< Side View >

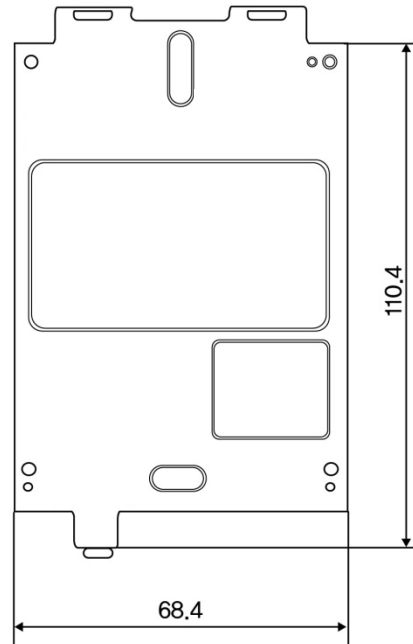

< Wall Bracket >

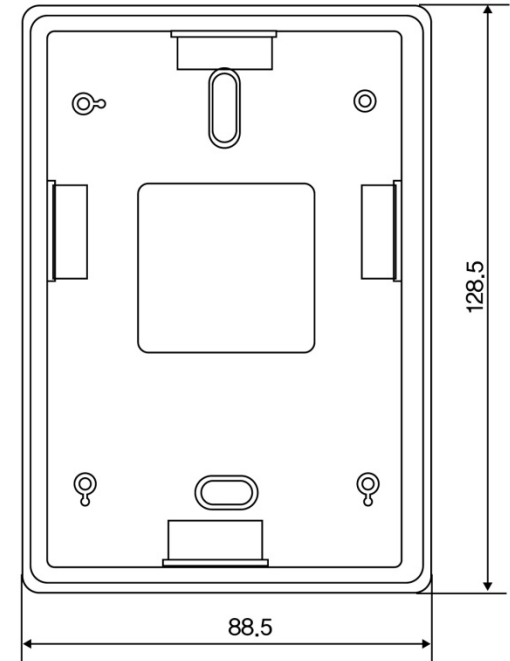

< Extended bracket >

Cables and Connectors

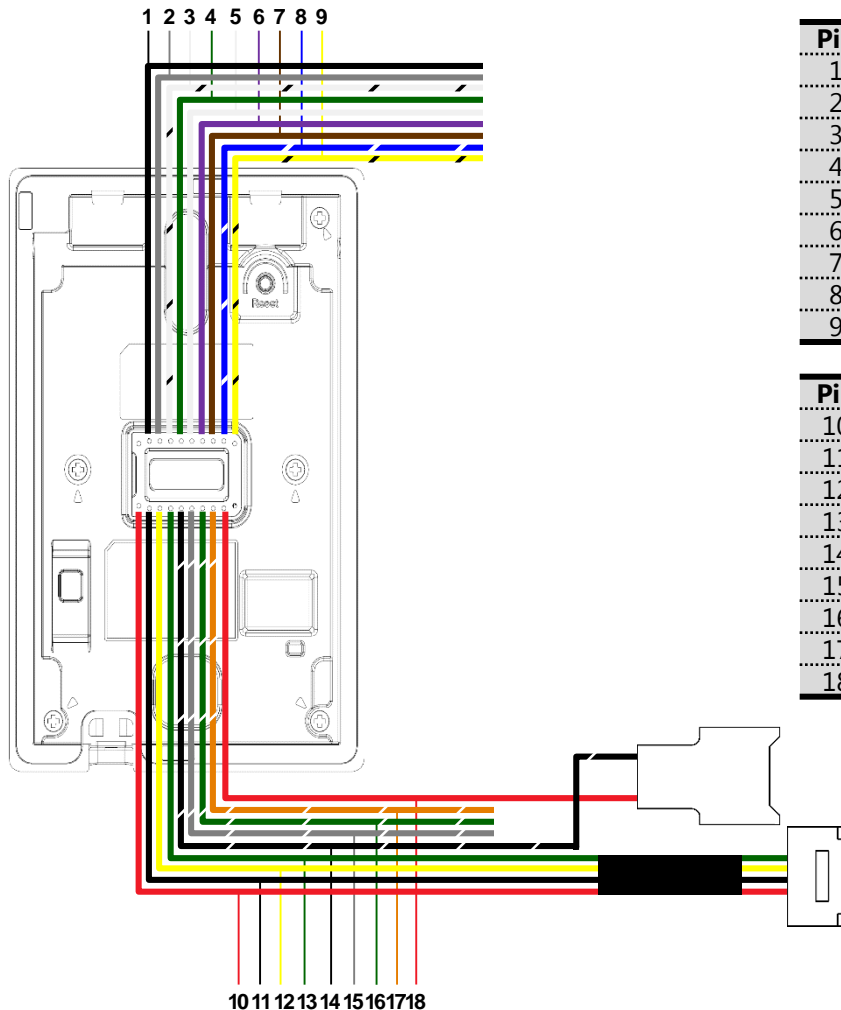

Pin	Pin Name	Description	Color
1	WG GND	Wiegand Ground	Black
2	TTL GND	Switch Ground	Grey
3	485 GND	RS485 Ground	Black with diagonal stripes
4	WG D0	Wiegand Data 0	Green
5	WG D1	Wiegand Data 1	Blue
6	TTL IN0	Switch Input 0	Purple
7	TTL IN1	Switch Input 1	Brown
8	485 TRXP	RS485 TRX+	Blue with diagonal stripes
9	485 TRXN	RS485 TRX-	Yellow with diagonal stripes

Pin	Pin Name	Description	Color
10	ENET TXN	ETH TXN (LAN)	Red
11	ENET TXP	ETH TXP (LAN)	Black
12	ENET RXN	ETH RXN (LAN)	Yellow
13	ENET RXP	ETH RXP (LAN)	Green
14	PWR GND	Power Ground	Black with diagonal stripes
15	RLY NO	Relay Normal Open	Grey with diagonal stripes
16	RLY COM	Relay Common	Green with diagonal stripes
17	RLY NC	Relay Normal Close	Orange with diagonal stripes
18	PWR +VDC	Power In	Red

Power Connection

Pin	Pin Name	Color
18	PWR +VDC	Red
14	PWR GND	Black (White Stripe)

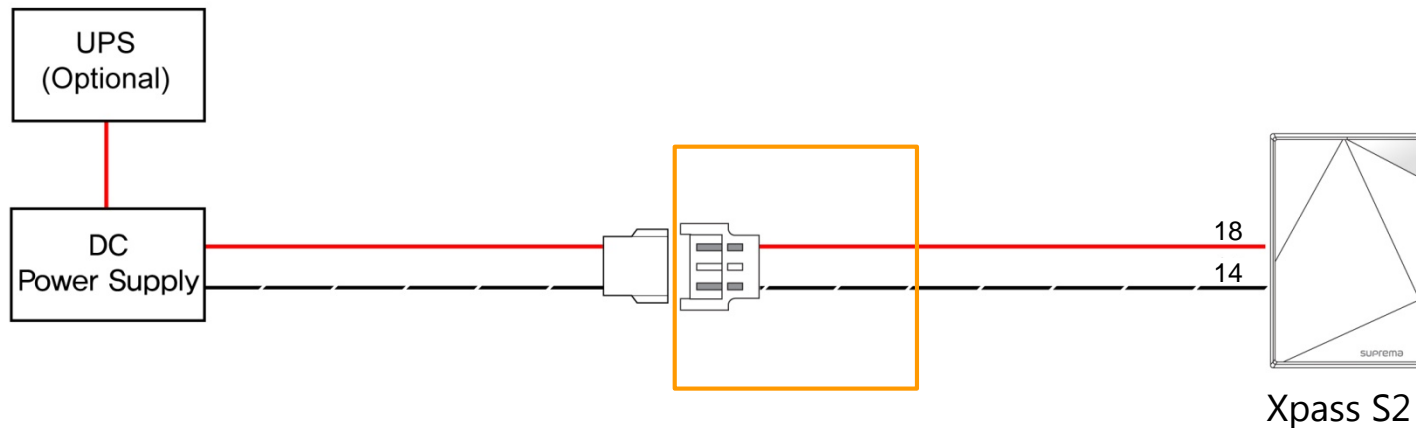

Recommended power supply

- 12VDC \pm 10%, at least 1500mA.
- Comply with standard IEC/EN 60950-1.
- Use a separate power supply for Secure I/O, electric lock and Xpass S2 respectively. If connecting and using the power supply to these devices together, the devices may malfunction.

LAN Connection

- **Ethernet Connection (Connection with HUB)**

The device can be connected to a network using a regular Ethernet hub.

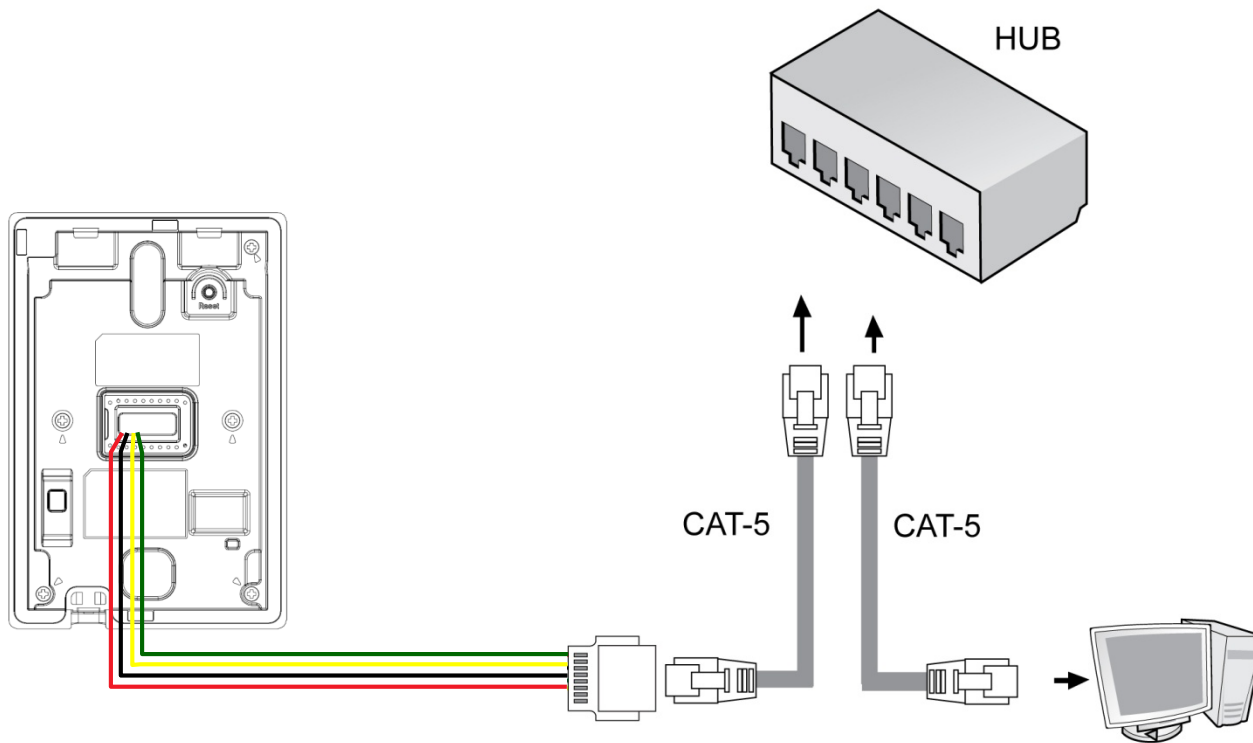

LAN Connection (Direct connection with PC)

- **Ethernet Connection (Direct connection with PC)**
Use a standard CAT-5 cable to connect the device directly to a PC.

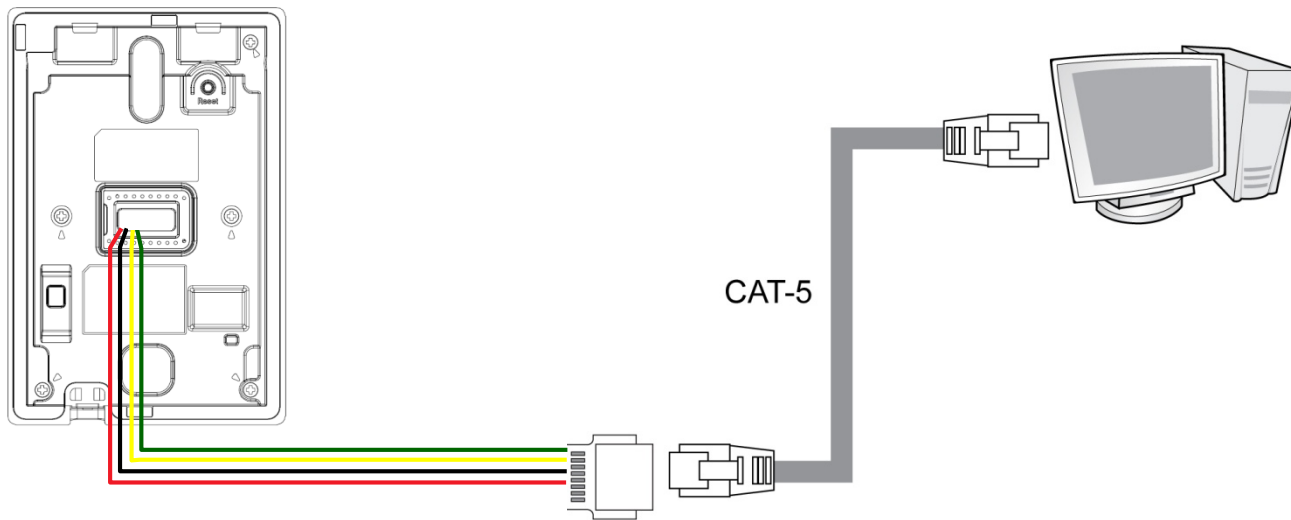

RS485 Connection for Host Communication

Pin	Pin Name	Color
8	485 TRXP	Blue (White Stripe)
9	485 TRXN	Yellow (Black Stripe)
3	485 GND	White (Black Stripe)

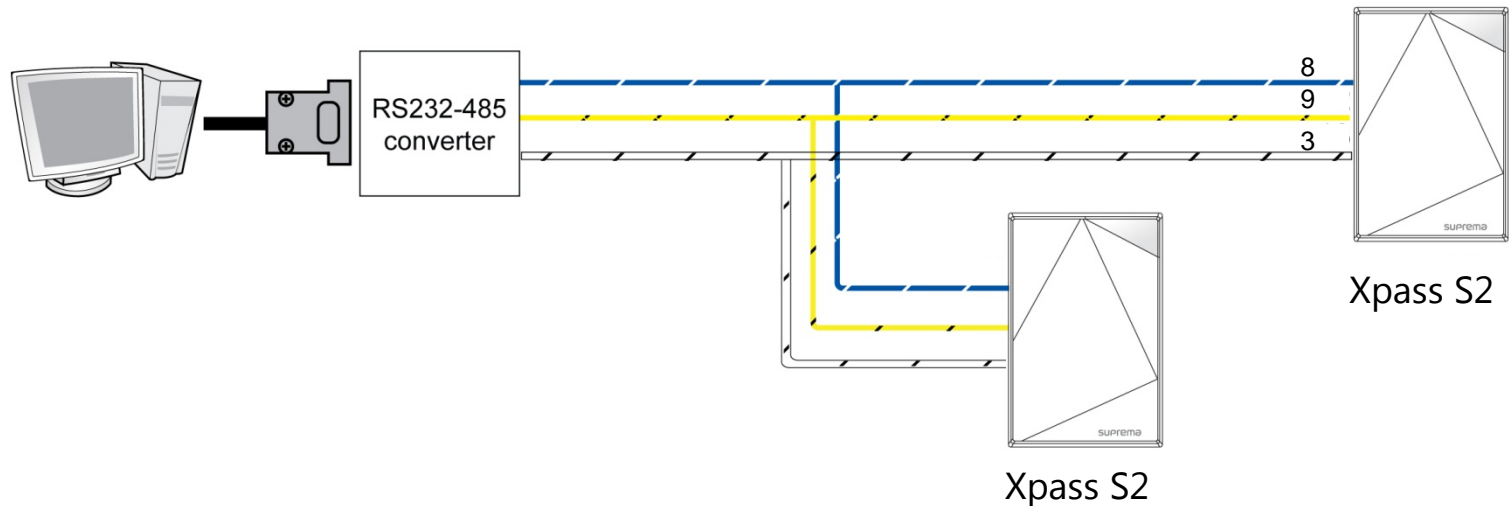

Notes

- Only the devices at the both ends of the bus should be terminated. To enable termination on the RS232-485 converter, refer to the converter's manual.
- Adjust the communication speed as needed. The signal quality vary depending on wiring conditions, and it may be necessary to lower the Baud rate.
- The GND signal may be omitted if and only if the GND potential difference is less than $\pm 5V$.

RS485 Connection for Secure I/O

Pin	Pin Name	Color
8	485 TRXP	Blue (White Stripe)
9	485 TRXN	Yellow (Black Stripe)
3	485 GND	White (Black Stripe)

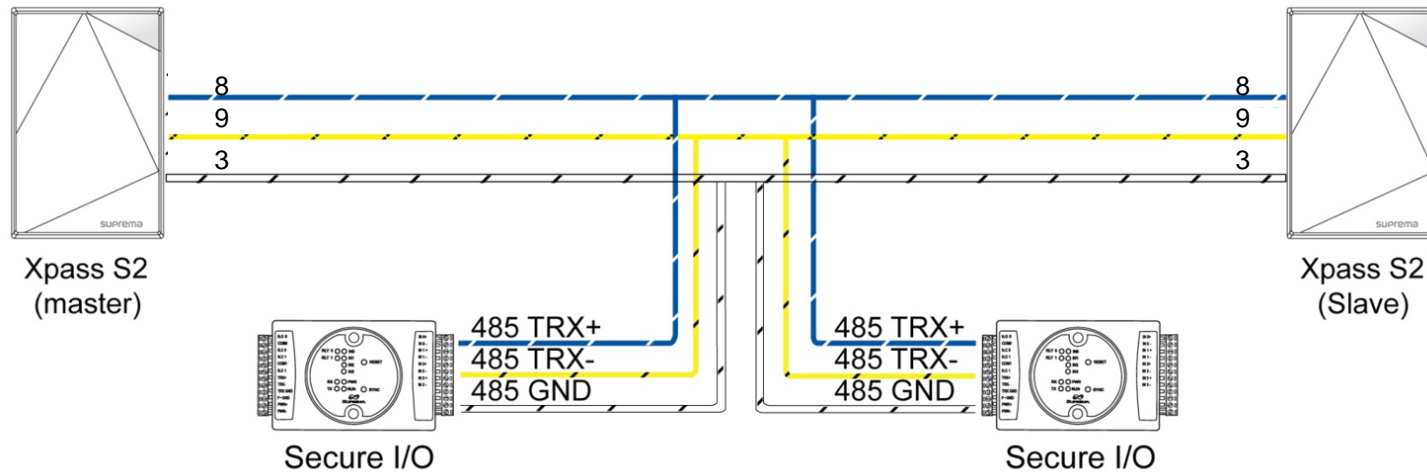

Max number of devices

Maximum eight (8) devices (including Master) interworks in an RS485 loop.

Relay Connection – Fail safe lock

Pin	Pin Name	Color
16	RLY COM	Green (White Stripe)
17	RLY NC	Orange (White Stripe)

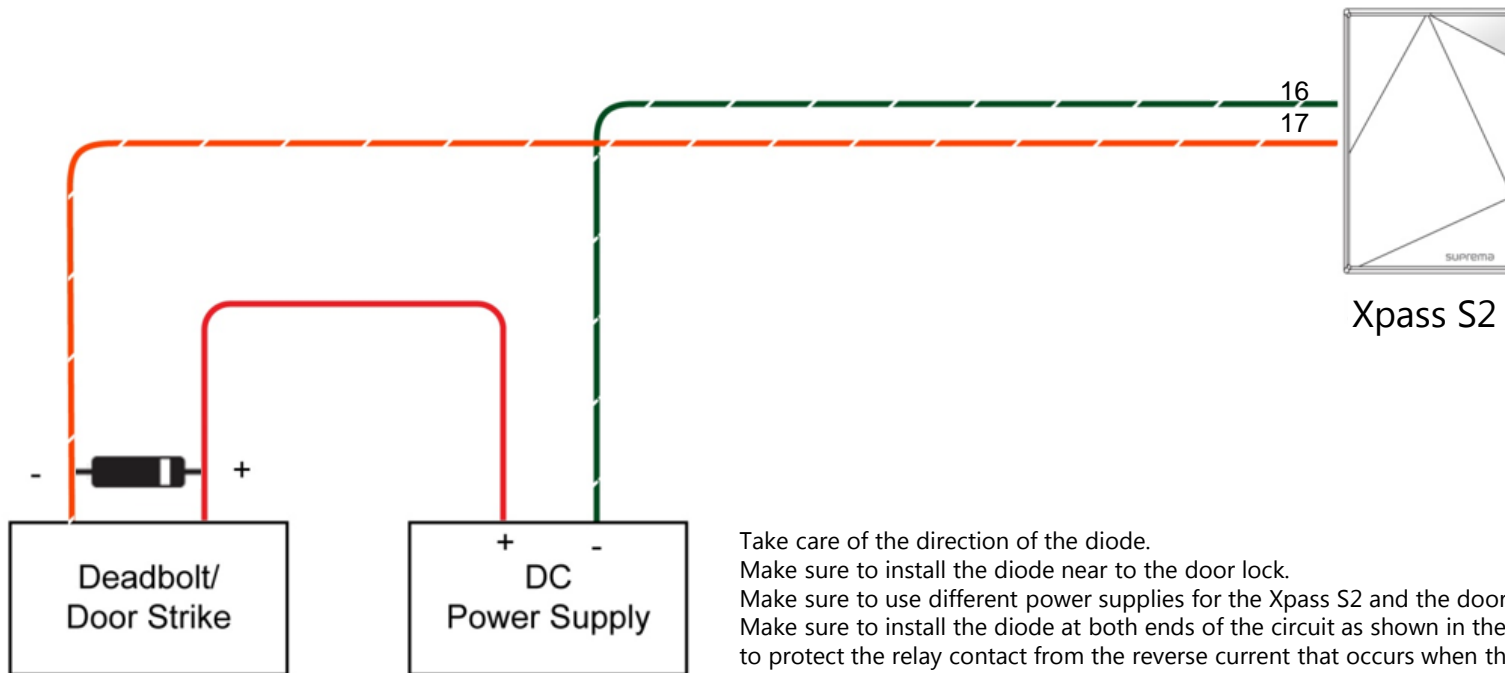

Take care of the direction of the diode.
 Make sure to install the diode near to the door lock.
 Make sure to use different power supplies for the Xpass S2 and the door lock.
 Make sure to install the diode at both ends of the circuit as shown in the figure left in order to protect the relay contact from the reverse current that occurs when the door lock works.

Relay Connection – Fail secure lock

Pin	Pin Name	Color
15	RLY NO	Gray (White Stripe)
16	RLY COM	Green (White Stripe)

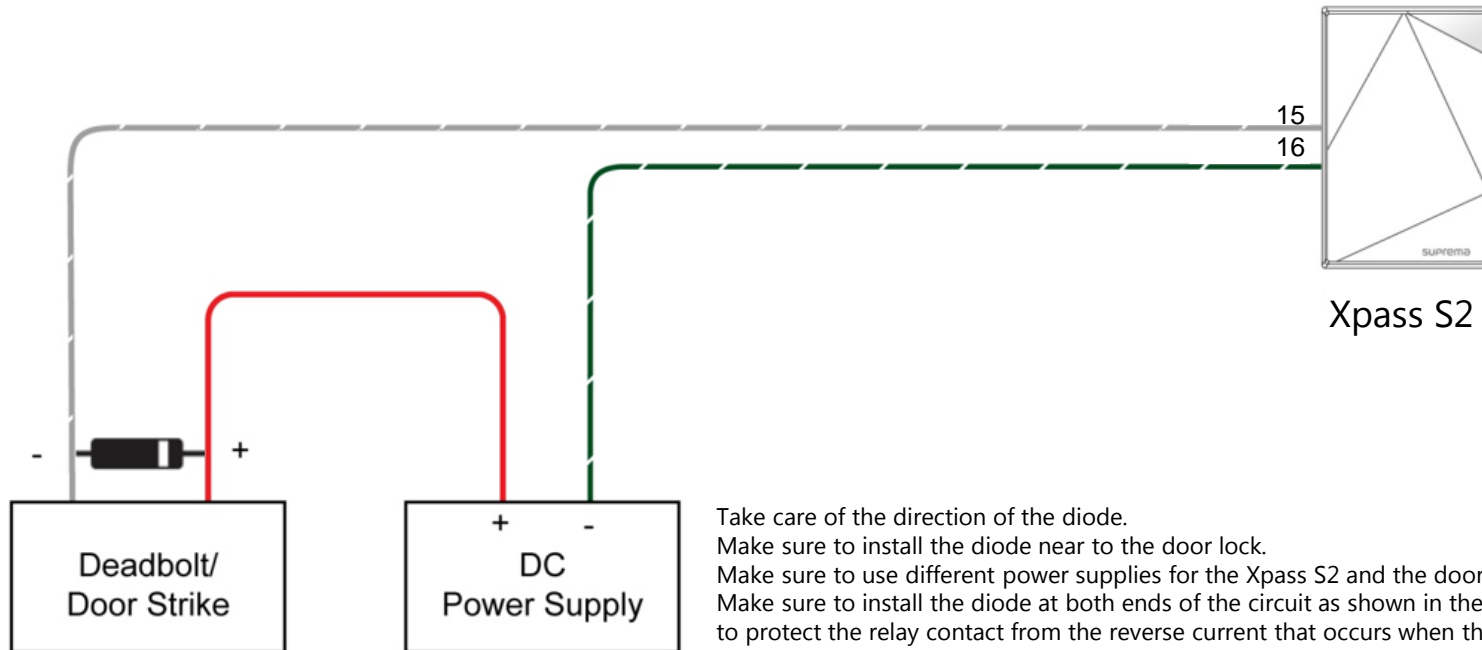

Take care of the direction of the diode.
 Make sure to install the diode near to the door lock.
 Make sure to use different power supplies for the Xpass S2 and the door lock.
 Make sure to install the diode at both ends of the circuit as shown in the figure left in order to protect the relay contact from the reverse current that occurs when the door lock works.

Relay Connection – Automatic Door

Pin	Pin Name	Color
15	RLY NO	Gray (White Stripe)
16	RLY COM	Green (White Stripe)

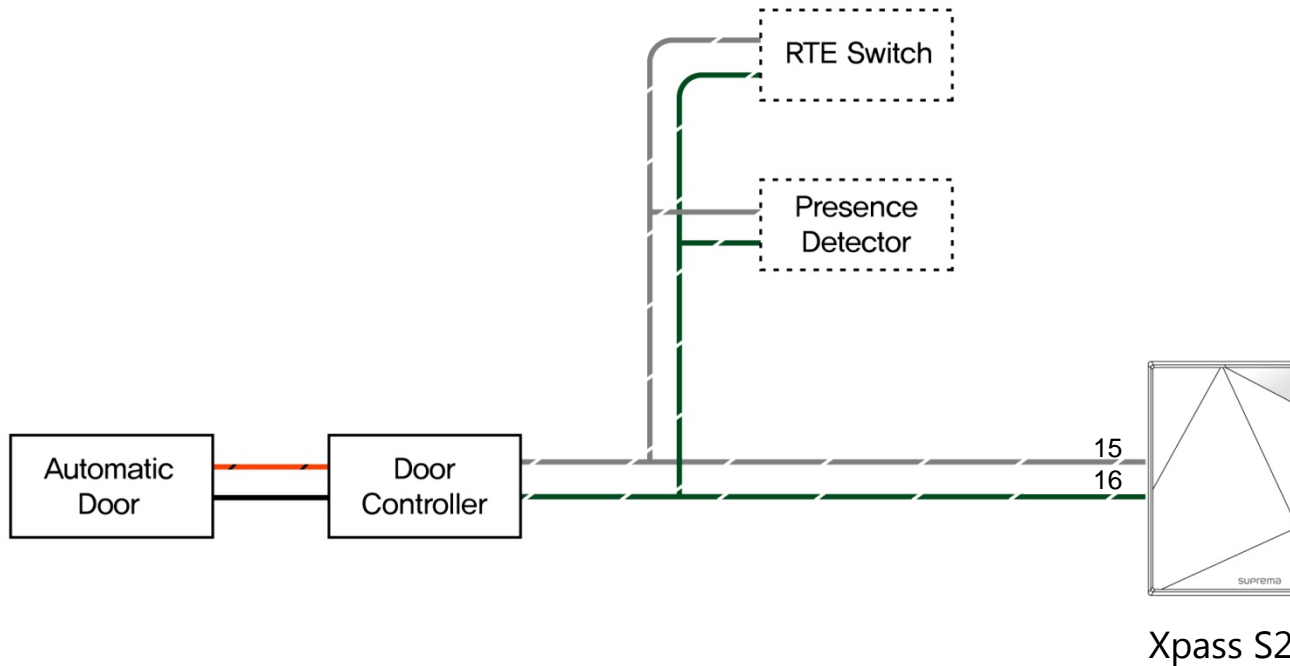

Digital Input Connection (Alarm, Emergency S/W)

Pin	Pin Name	Color
7	TTL IN1	Brown
2	TTL GND	Gray
6	TTL IN0	Purple

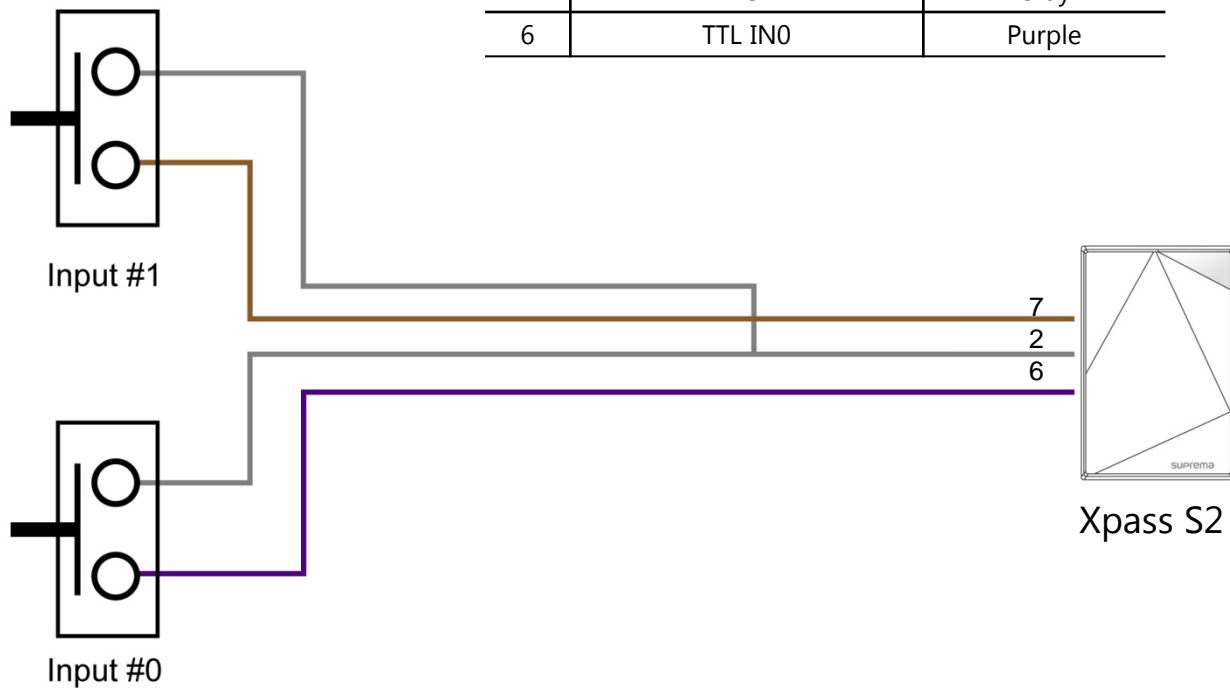

Digital Input Connection (RTE, Door Sensor)

Pin	Pin Name	Color
7	TTL IN1	Brown
2	TTL GND	Gray
6	TTL IN0	Purple

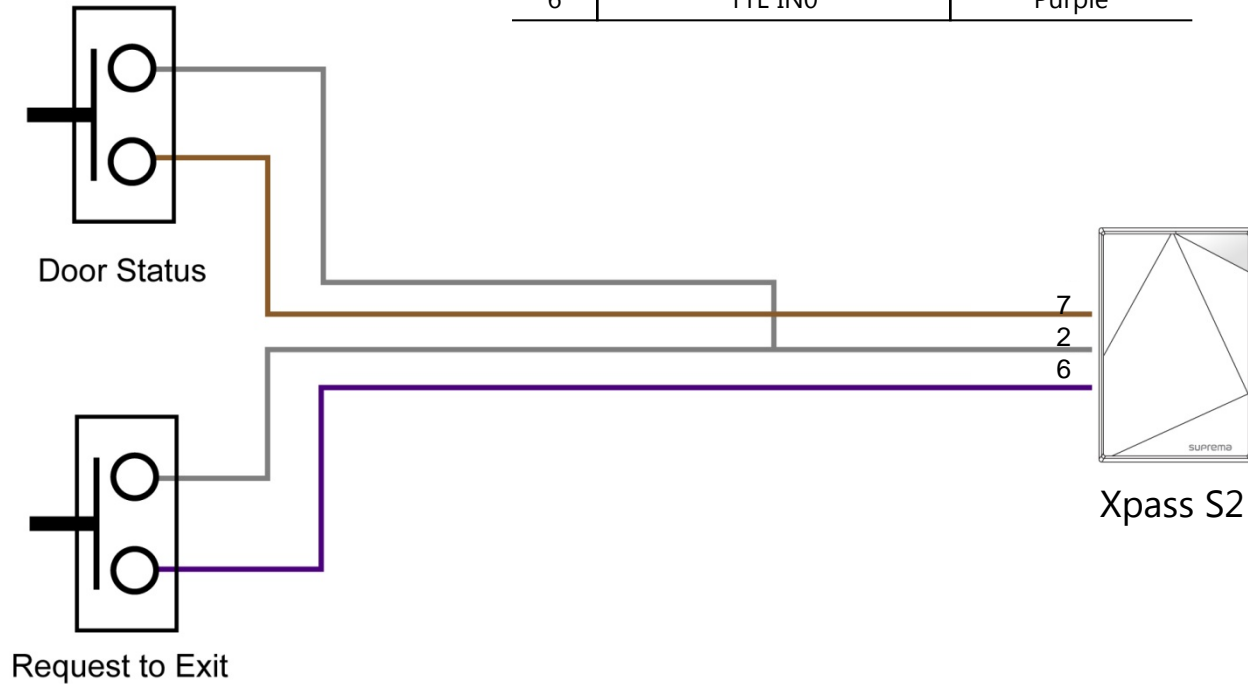

Wiegand Input/Output

Wiegand Input

Pin	Pin Name	Color
4	WG D0	Green
5	WG D1	White
1	WG GND	Black

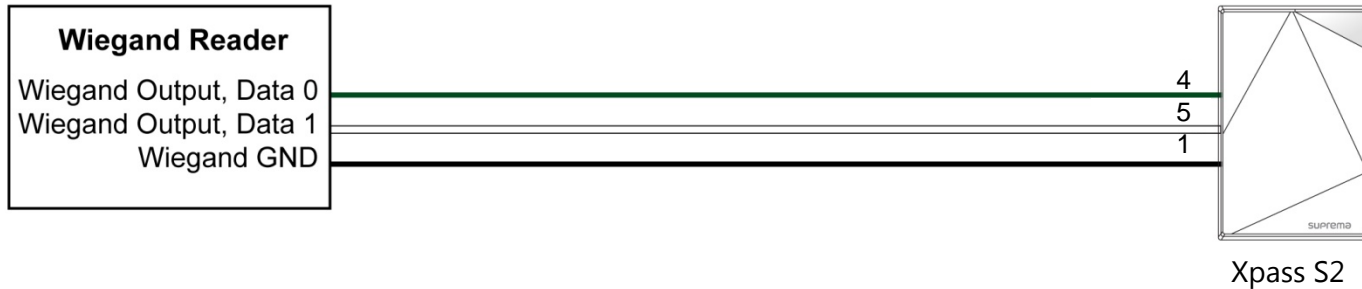

Wiegand Output

Pin	Pin Name	Color
4	WG D0	Green
5	WG D1	White
1	WG GND	Black

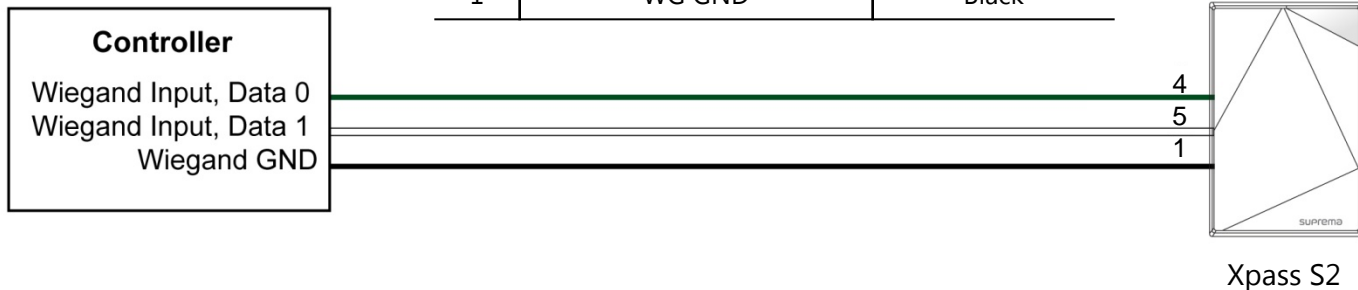

Installation of Wall-mount Bracket

- **Fix wall mount bracket on a wall using wall mounting screws**

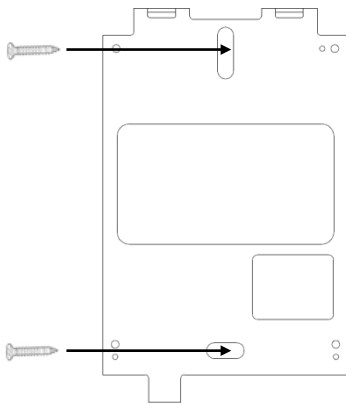

- **Hook Xpass S2 on the wall mount bracket**

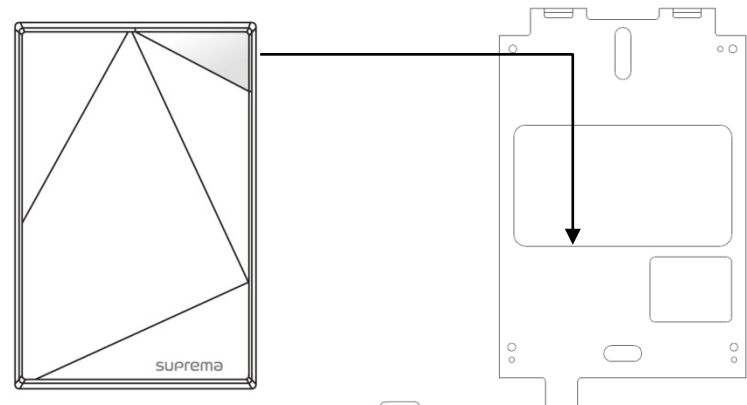

- **Fix Xpass S2 to the wall mounting bracket using a wall mounting screw**

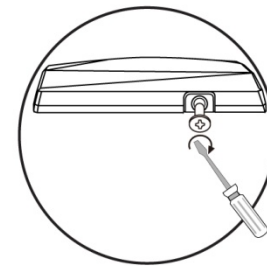

Installation of Extended Bracket

- **Assemble the extended bracket using screws**

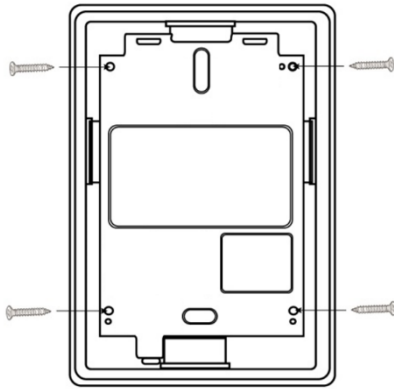

- **Mount the extended bracket to the desired location using screws**

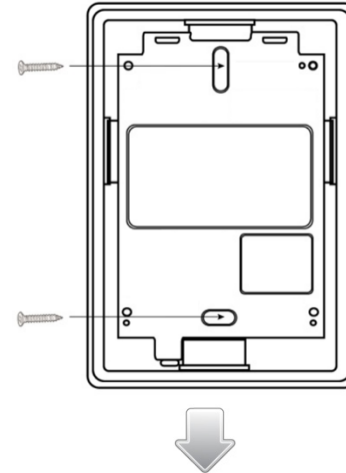

- **Fix Xpass S2 and the extended bracket using screws**

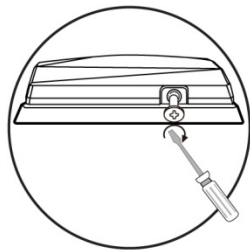

- **Hook Xpass S2 on the extended bracket**

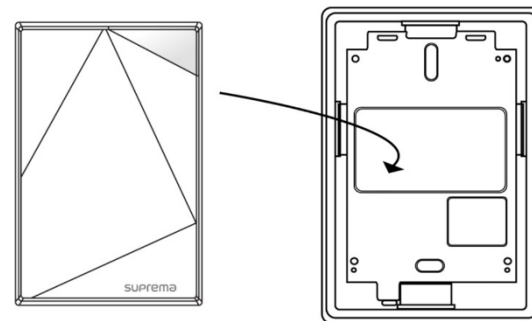

Installation Reference 1 - Standalone

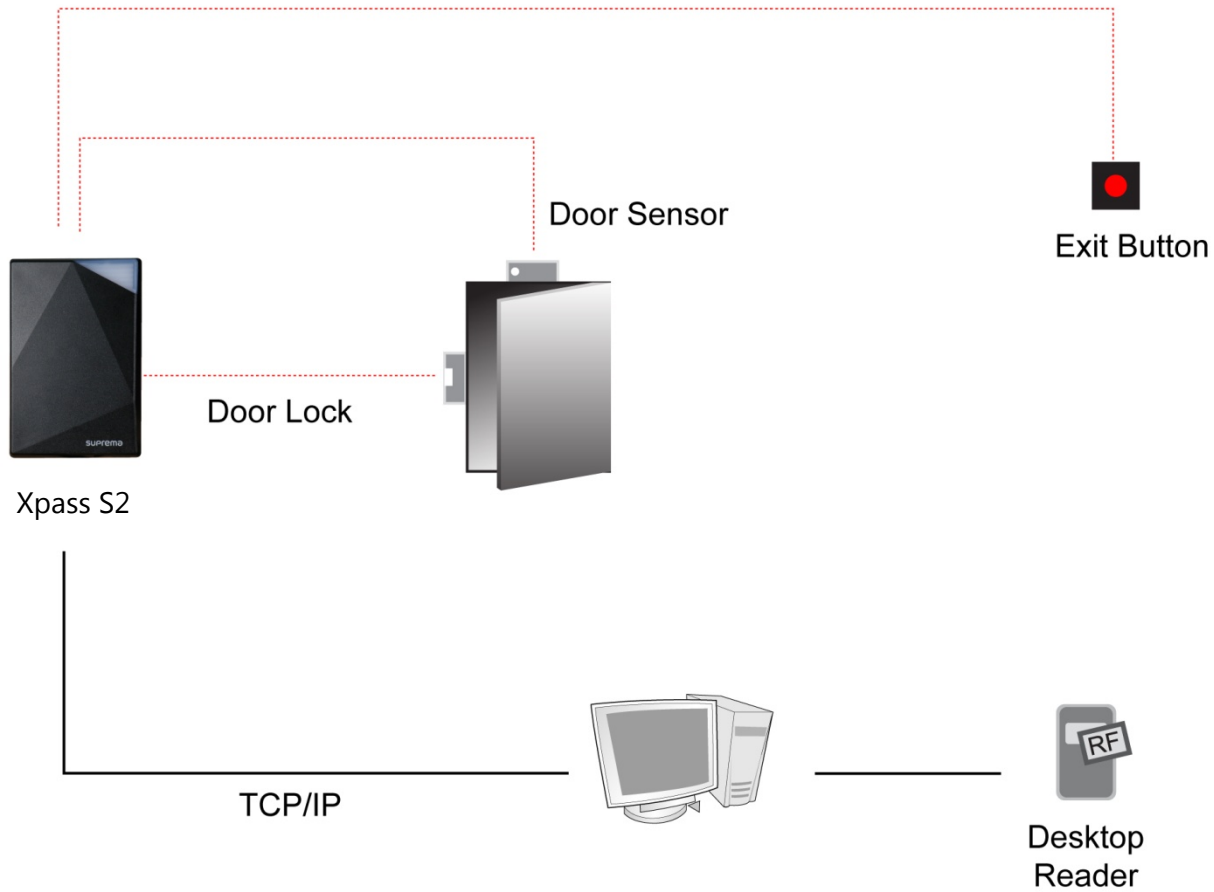

Installation Reference 2 – Standalone (Secure)

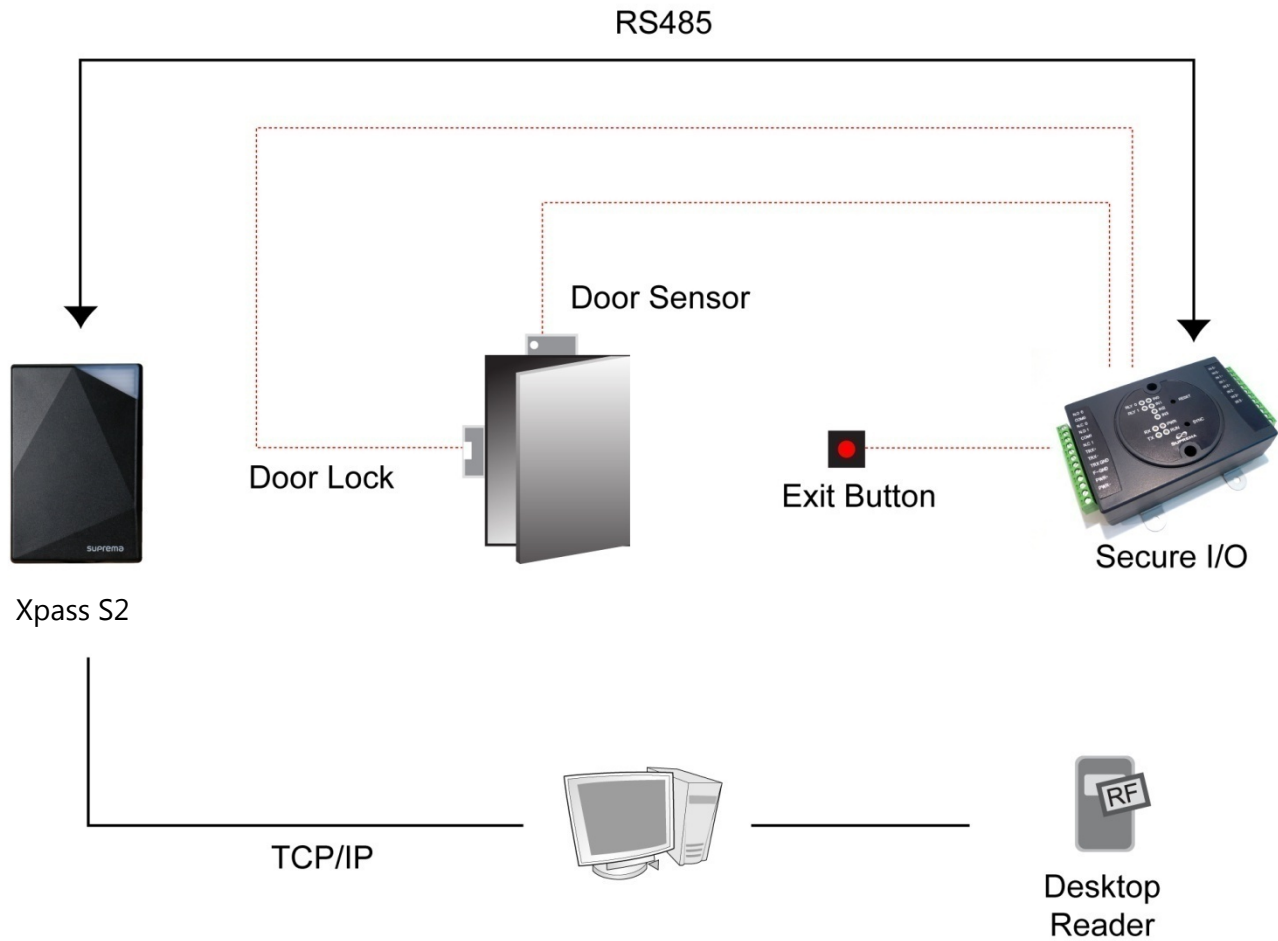

Installation Reference 3 – Network

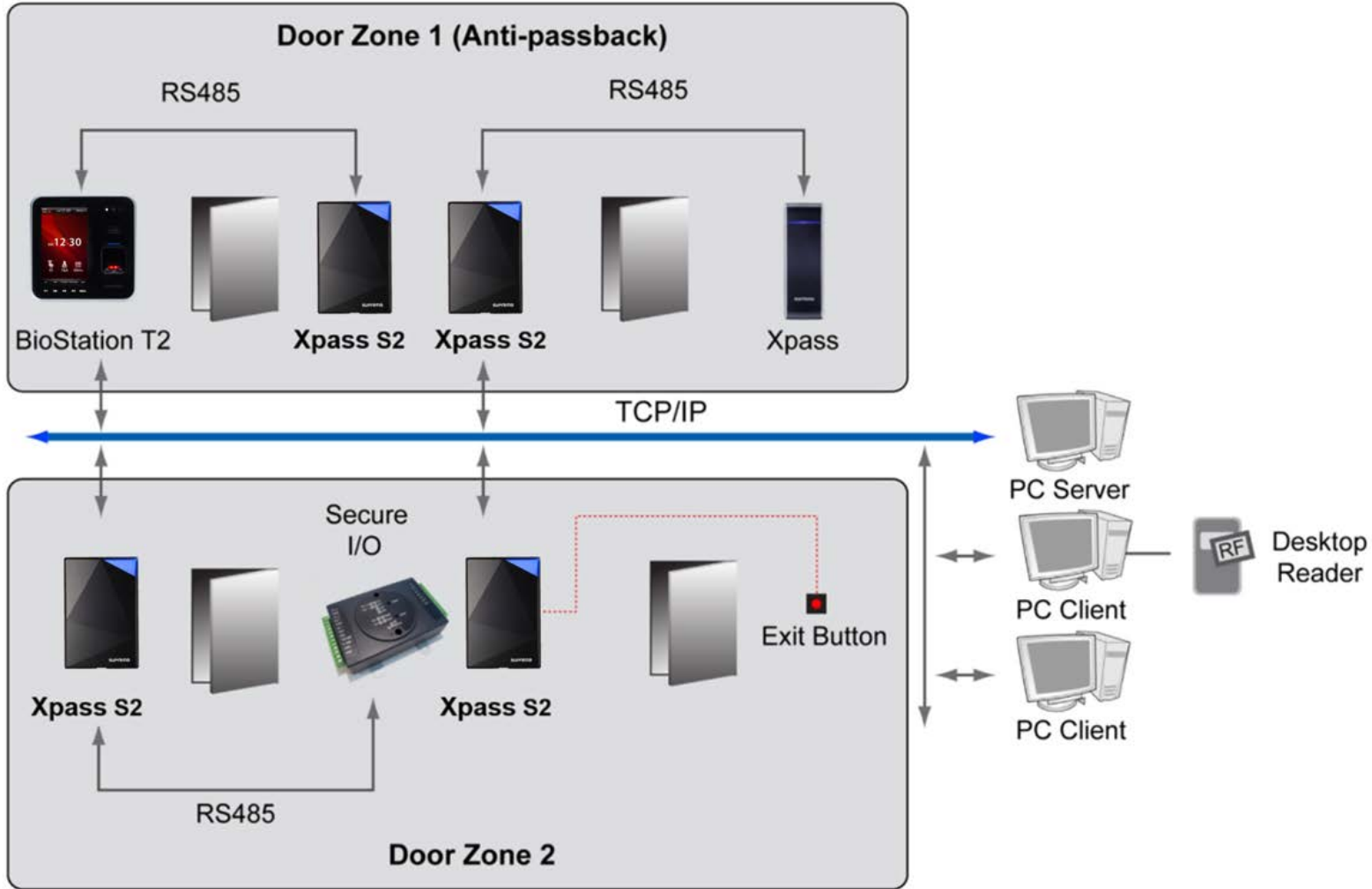

Specification

CPU	32-bit Microprocessor (533Mhz)	
Memory	16MB Flash + 16MB SDRAM	
RF Card	13.56MHz ISO14443A/B, ISO15693, Mifare, Desfire (CSN), Felica	
User Capacity	50,000 users	
Log Capacity	100,000 events	
Interfaces	TCP/IP, RS485, Wiegand In or Out	
IP Rate	IP65 dust and water protection	
Sound	Multi-tone buzzer	
LED	Multi-color LED	
Input & Output	Relay x 1 Switch input x 2	
Power	12VDC	
Operating Temperature	-35°C to 65°C	
Dimensions	Xpass S2	80 x 120 x 11.4mm (W x H x D)
	Wall Bracket	68.4 x 110.4mm (W x H)
Certificates	CE, FCC, KC, IP65, RoHS, REACH, WEEE	

Electrical Specification

	Min.	Avg.	Max.	Notes
Power				
Voltage (V)	10	12	13	Use regulated DC power adaptor only
Current Consumption (mA)	-		270	
Switch Input				
VIN_MAX (V)	-	-	5	
Relay				
Voltage	-	-	24 VDC	
Current	-	0.5 A	1.0 A	

FCC Rules

Caution

Changes or modifications not expressly approved by the manufacturer responsible for compliance could void the user's authority to operate the equipment.

Warning

This device complies with part 15 of the FCC Rules. Operation is subject to the following two conditions: (1) This device may not cause harmful interface, and (2) this device must accept any interface received, including interference that may cause undesired operation.

Information to User

This equipment has been tested and found to comply with the limit of a Class B digital device, pursuant to Part 15 of the FCC Rules. These limits are designed to provide reasonable protection against harmful interference in a residential installation. This equipment generates, user and can radiate radio frequency energy and, if not installed and used in accordance with the instructions, may cause harmful interference to radio communications.

However, there is no guarantee that interference will not occur in a particular installation; if this equipment does cause harmful interference to radio or television reception, which can be determined by turning the equipment off and on, the user is encouraged to try to correct the interference by one or more the following measures:

1. Reorient / Relocate the receiving antenna.
2. Increase the separation between the equipment and receiver.
3. Connect the equipment into an outlet on a circuit difference from that to which the receiver is connected.
4. Consult the dealer or an experienced radio/TV technician for help



Suprema Inc.

16F Parkview Tower, 6 Jeongja, Bundang, Seongnam, Gyeonggi, 463-863 Korea

Tel: +82-31-783-4502 | Fax: +82-31-783-4503

Email: sales@supremainc.com | Homepage: www.supremainc.com