



FaceStation

User Manual

Version V1.3

www.supremainc.com

Important Safety Information

Carefully review the information within the user manual before installing/operating the device.
Pay careful attention to the warning and cautions below as they are here to prevent any risk/damage to any person(s) or property associated with the device.



Warning

Failure to heed these warnings may lead to serious injury or even death!

Installation

- Do not install the device near areas with direct sunlight, high humidity, soot or dust.
- Do not install the device near heat sources such as radiators, heat registers, and stoves.
- Do not install the device near areas of large electromagnetic interference.

Usage

- Do not disassemble, repair or reconstruct the device.
Contact your nearest Suprema dealer for technical support.
- Do not obstruct or place wet objects near/on the vent.
- Do not place liquids such as water, beverages and other solutions near/on the device.
- Only use the device its intended use.



Caution

Failure to heed these cautions may lead to minor injury or damage the device.

Installation

- Do not leave cables (especially power cables) exposed to the outer environment.
- Do not install the device near objects with a strong magnetic field such as magnets, computer monitors (especially CRT), TV screens, and speakers.
- Secure I/O, the electrical locking device and access controller must use independent power source.

Usage

- Do not apply heavy pressure to or use sharp objects with the touchscreen LCD.
- Do not drop or apply any physical shock/impact to the device.
- Regularly clean the product with a soft dry cloth; avoid benzene or alcohol.

Contents

1 Getting Started	6	Power Connection	18
Features	7	Wireless LAN Connection	18
Components	8	Ethernet Connections	19
Optional Accessories	9	Connecting with a PC	19
Product Description	10	Connecting with Hub	19
Dimensions	12	RS485 Connections	20
2 Installation	13	Connecting with a PC	20
Installation Precautions	14	Connecting with Secure I/O	20
Basic Installation	15	Connecting with Other Devices	20
3 Connections	16	RS232 Connection	21
Cable Specifications	17	Relay Connections	22
Power Cable	17	Connecting with a Fail Safe Lock	22
RS232 Cable	17	Connecting with a Fail Secure Lock	22
Relay Cable	17	Connecting with Automatic Doors	22
RS485 Cable	17	Input Connection	23
Wiegand Cable	17	Wiegand Connections	23
Analogue Video Phone Cable	17	Connecting a Wiegand Input	23
Switch Cable	17	Connecting a Wiegand Output	24
		Mini USB Connection	24
		USB Connection	25
		Analogue Video Phone Connection	25

Contents

4 Device Configuration	26	Checking Device Information	38
FaceStation Menu Tree	27	Checking Memory Status	38
Network Settings	28	TouchScreen Calibration	39
Setting TCP/IP	28	Device Reset.....	39
Setting Server	29	Factory Default.....	39
Setting Serial Communication	29	Camera	39
Setting USB	30	Display and Sound Settings	40
Using USB Memory Device	30	Theme	40
Setting WLAN (Only for wireless models)	31	Background	40
Operation Mode Settings	31	Voice Instruction	40
Face Authentication Mode.....	32	Menu Timeout	40
Card Authentication Mode	32	Pop-Up Time	40
ID Authentication Mode	33	Backlight Timeout	41
Setting General Operational Parameters	33	Volume	41
Time and Attendance Mode	34	Language	41
Device Settings	34	Central Time Display.....	41
Setting Face Authentication Settings.....	35	Date Display	41
Setting Interphone	36	Authentication Alert	41
Setting Time	38		

5 Device Operation	42	Using Time and Attendance	53
Basic Screen Views	43	Checking Time and Attendance	54
Face Authentication Screen	43	Viewing Logs	54
Home Screen	43	Log List	54
Device Status Screen	44	Log Search	55
User Management.....	45	Delete All Logs	55
User Registration	45	Log Info.....	55
Modifying User Information	48	Appendix	56
Deleting a User	49	Specifications	57
Deleting All Users	50	Product Specifications	57
Searching for a User	50	Electric Specifications	57
Checking User Capacity	50	Troubleshooting.....	58
Authentication Modes.....	51	FCC Rules	58
Face Authentication Procedure	51	Device Font License	58
Face Authentication Modes	52	Quality Assurance.....	60
Card Authentication Modes	52	Index.....	61
ID Authentication Modes	53		

1 Getting Started







Features

Components

Product Description

Dimensions

Features

4.3" Touchscreen LCD		The 4.3" WVGA touchscreen LCD provides a robust and precise interface to an intuitive GUI allowing for easy operation and access to the device.
Next Generation Face Recognition Technology		By combining state-of-the-art technology with Suprema's proprietary algorithms, FaceStation provides querying speeds of up to 1:1000 matches per second. Using twin camera technology FaceStation is able to store both facial stamps using a visual camera as well as complex facial templates using the IR camera.
Various Interface Supported		FaceStation comes with a variety of network interfaces such as TCP/IP, WiFi, RS485, RS232, Wiegand, and USB.
Video Phone		FaceStation's built-in camera, microphone and speaker provide the device with the ability to be integrated with conventional analogue video phones, VoIP video phones or PC software to create.
RF Card Support		Mifare Classic, Mifare Plus, and Mifare DesFire (CSN) cards are supported.
Powerful Dual-CPU Architecture		A powerful 1.1GHz DSP is dedicated to handling facial template operations and a 667MHz RISC processor ensures uninterrupted device operations.

Getting Started

Components

FaceStation



Wall Mounting Bracket (1)

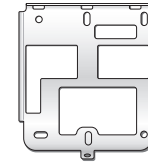

Software CD (1)

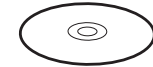

Wall Mount Screws (4)

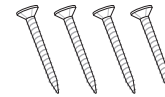

PVC Anchors (4)

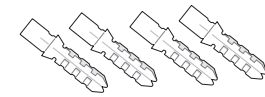

Ferrite Core (1)

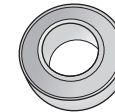

Power Cable (1)



RS232 Cable (1)



Relay Cable (2)

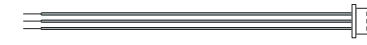

RS485 Cable (2)



Wiegand Cable (1)



Switch Cable (1)

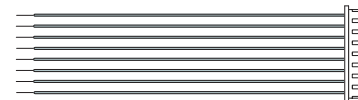

Video Phone Cable (1)



Optional Accessories

Power Adapter

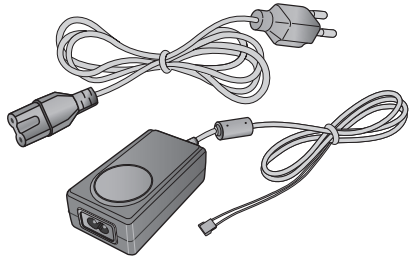

Secure I/O

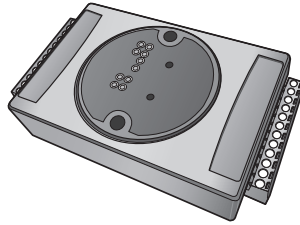

RF Card



Plastic Stand

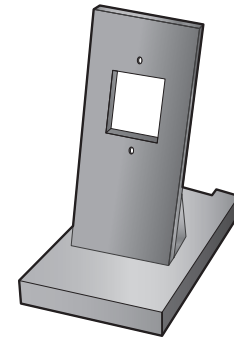

Mifare reader/writer

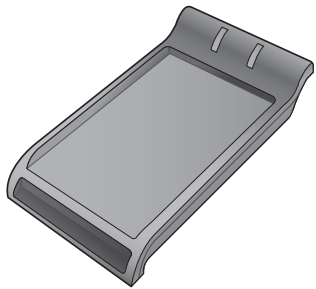

Video phone

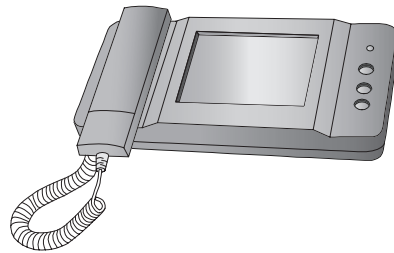

Wireless Access Point
(For Wireless Models Only)

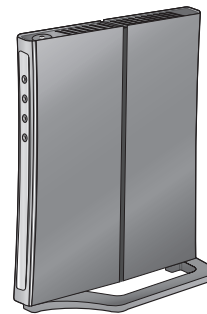

Product Description

Front



1	LCD Touchscreen	Used to display the device operating status and device operation.
2	Call Button	Used to place a call on the interphone.
3	Light LED	Used as a general lighting.
4	Infrared (IR) LED	Used as an IR light.
5	Camera	Detects and captures a face image.
6	Proximity Sensor	Determines the user's proximity.
7	Basic T&A Buttons (F1 – F4)	Selects time and attendance events.
8	Microphone	Used to communicate with the interphone.

Note

The RF antenna, used to scan RFID cards, is built around the IR LEDs.

Rear and Bottom

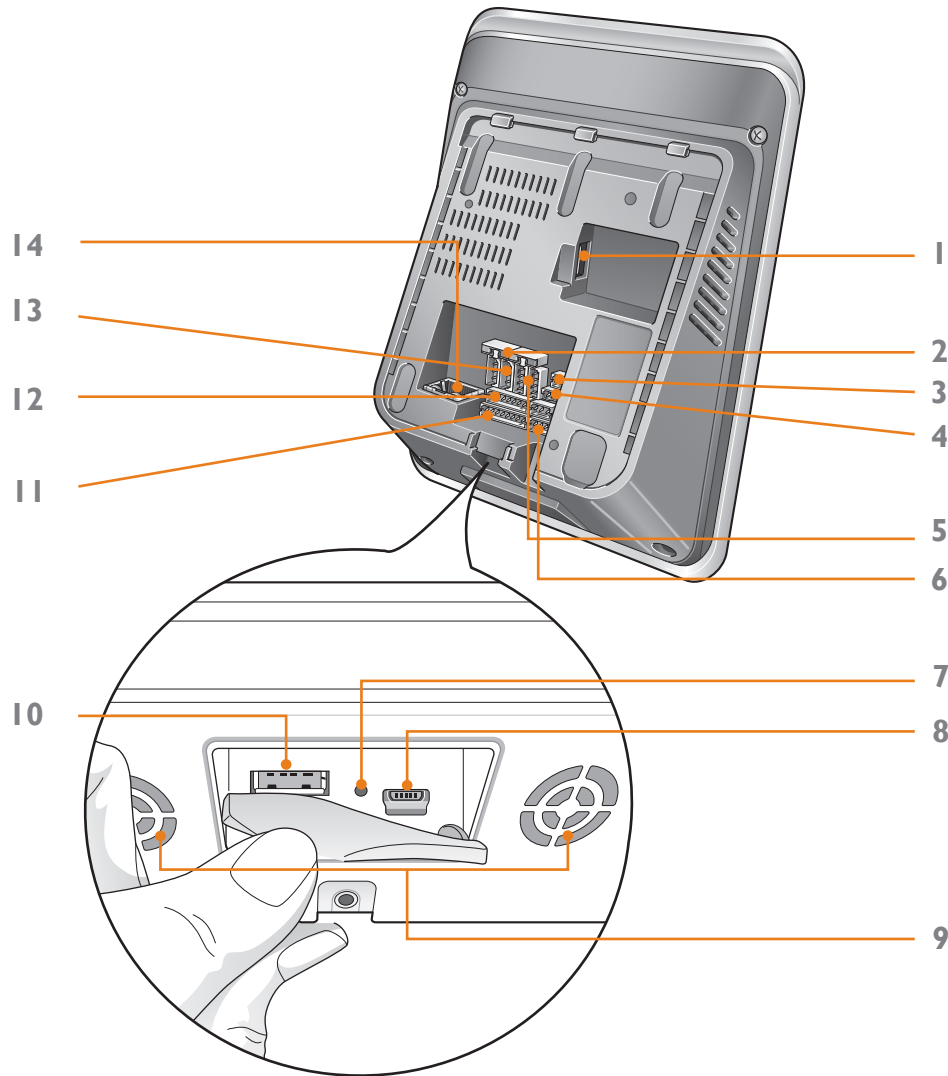

1	USB Wireless LAN Port	Used for the wireless LAN module.
2	Termination Switch	Enables RS485 termination.
3	PWR Connectors	Connects to the 2-pin power cable.
4	RS232 Connectors	Connects to the 3-pin RS232 cable.
5	RS485 Connectors	Connects to the 4-pin RS485 cable.
6	Wiegand Connectors	Connects to the 5-pin Wiegand cable.
7	Reset Button	Resets the device.
8	Mini USB Port	Connects with a PC.
9	Speaker	Audio output from the device
10	USB type A Port	Connects to a USB memory device.
11	Input Terminal	Connects to the 8-pin input cable.
12	Analogue Video	Connects to the 7-pin analogue video phone cable.
13	Output Relay Terminal	Connects to two 3-pin relay cables.
14	Ethernet Port	Connects an Ethernet cable.

Dimensions

FaceStation

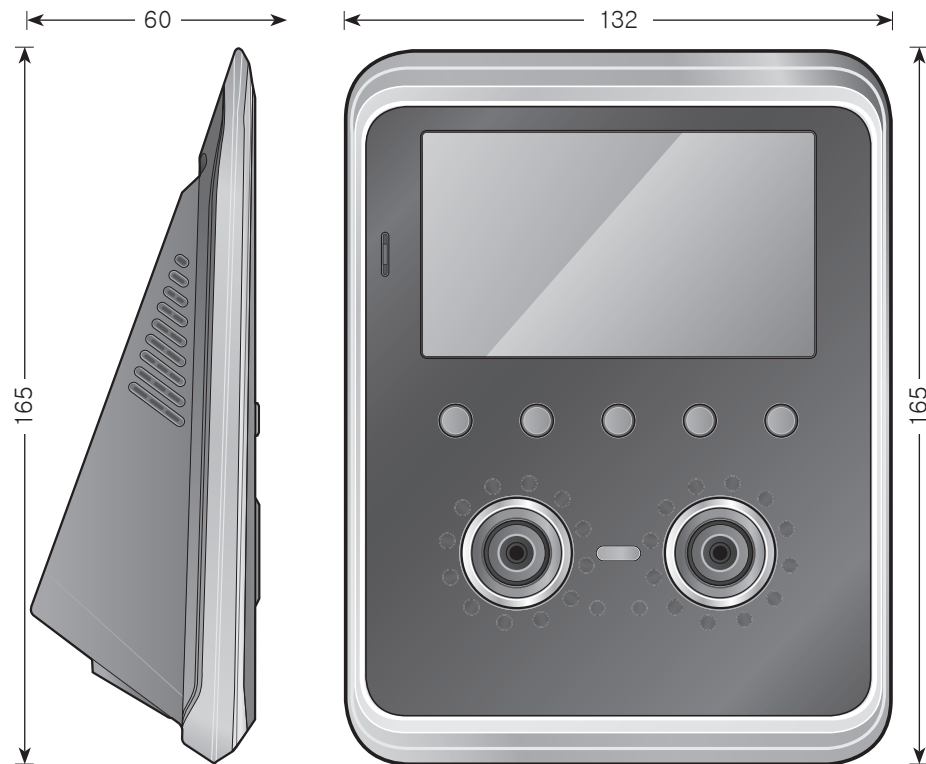

Wall Bracket

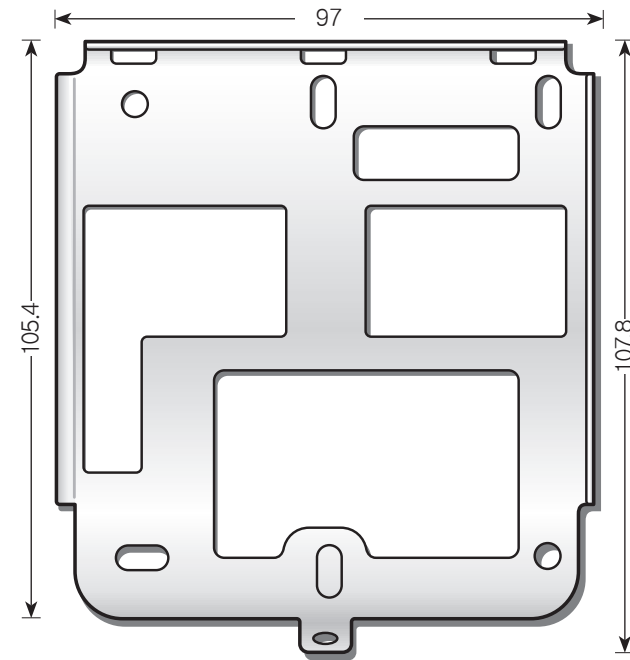

2 Installation

Installation Precautions

Basic Installation

Installation Precautions

FaceStation is a state-of-the-art face recognition terminal using Suprema's advanced adaptive IR illumination technology. Please pay care attention to the precautions and instructions to maximize its performance.

Installation Location

- Optimal Installation Height: 120cm (Ideal for user height's between 155cm – 205cm)
- It is recommended to determine the installation height based on the shortest user.
- A uniform installation height must be maintained when installing multiple devices for the same user group.
- The device is designed for indoor use.
- When installing the device near a window, install the device at least 3 meters from the window.
- Avoid installation locations where there is direct sunlight on or behind the face.

Recommended Installation Height

Recommended Installation Height	User Height Range	
	Minimum	Maximum
Bottom of the bracket		
90cm	125cm	175cm
100cm	135cm	185cm
110cm	145cm	195cm
120cm	155cm	205cm

※ The recommended installation height refers to the distance from the ground to the bottom of the bracket.

Basic Installation

As FaceStation two built-in cameras for face recognition, the correct installation height is extremely important to maximize the performance of the device. Select the optimal installation height for all users.

Installation

- 1** Place the bracket on the desired location.
- 2** Fix the bracket to the location using the insert anchors and screws.
- 3** Mount the device onto the bracket.
- 4** Fix the device to the bracket using the device mount screw.
- 5** Remove the transparent protective film from the device.

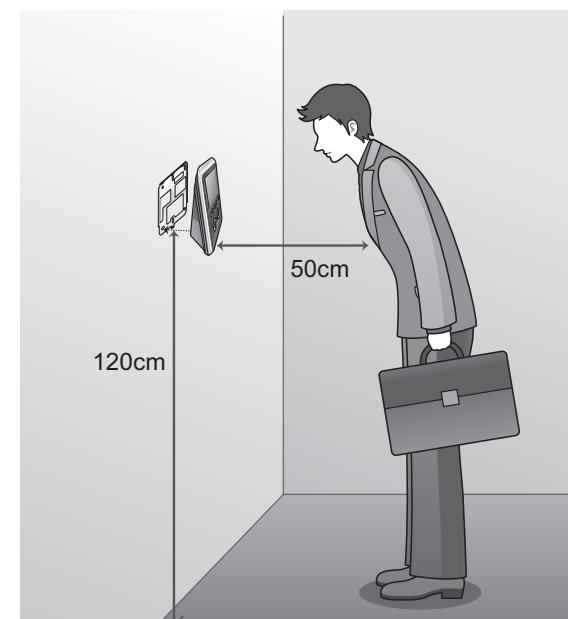
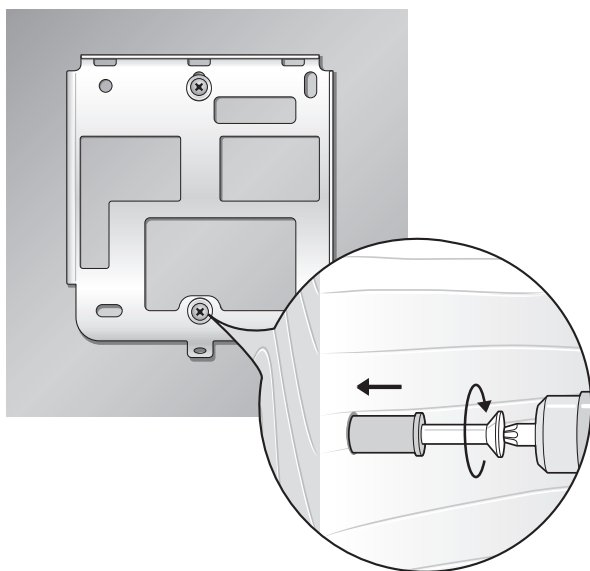

3 Connections

Cable Specifications

Power Connection

Wireless LAN Connection

Ethernet Connections

RS485 Connections

RS232 Connection

Relay Connections

Input Connection

Wiegand Connections

Mini USB Connection

USB Connection

Analogue Video Phone Connection

Cable Specifications

Power Cable

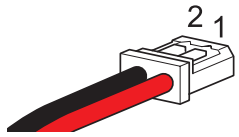

Pin	Name	Cable Type	Color
1	POW +	AWG24	RED
2	POW -		BLACK

RS232 Cable

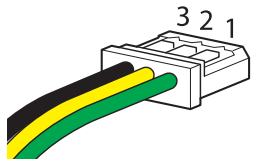

Pin	Name	Cable Type	Color
1	RS232 RX	AWG26	GREEN
2	RS232 TX		YELLOW
3	GND		BLACK

Relay Cable

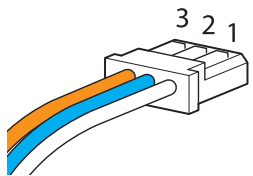

Pin	Name	Cable Type	Color
1	RELAY NORMAL OPEN	AWG24	WHITE
2	RELAY COMMON		BLUE
3	RELAY NORMAL CLOSE		ORANGE

RS485 Cable

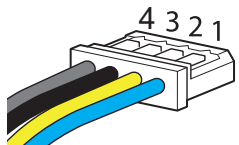

Pin	Name	Cable Type	Color
1	RS485 TRX+	AWG26	BLUE
2	RS485 TRX-		YELLOW
3	GND		BLACK
4	SHIELD GND		GRAY

Wiegand Cable

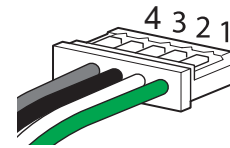

Pin	Name	Cable Type	Color
1	DATA0	AWG26	GREEN
2	DATA1		WHITE
3	GND		BLACK
4	SHIELD GND		GRAY

Analogue Video Phone Cable

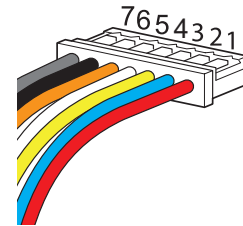

Pin	Name	Cable Type	Color
1	VOICE SIGNAL	AWG26	RED
2	GND		BLUE
3	POWER		YELLOW
4	VIDEO SIGNAL		WHITE
5	DOOR OPEN SIGNAL		ORANGE
6	GND		BLACK
7	SHIELD GND		GRAY

Switch Cable

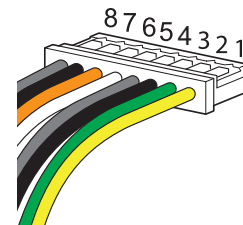

Pin	Name	Cable Type	Color
1	SWITCH INPUT0	AWG26	YELLOW
2	SWITCH INPUT1		GREEN
3	SWITCH GND		BLACK
4	SHIELD GND		GRAY
5	SWITCH INPUT2		WHITE
6	SWITCH INPUT3		ORANGE
7	SWITCH GND		BLACK
8	SHIELD GND		GRAY

Connections

Power Connection

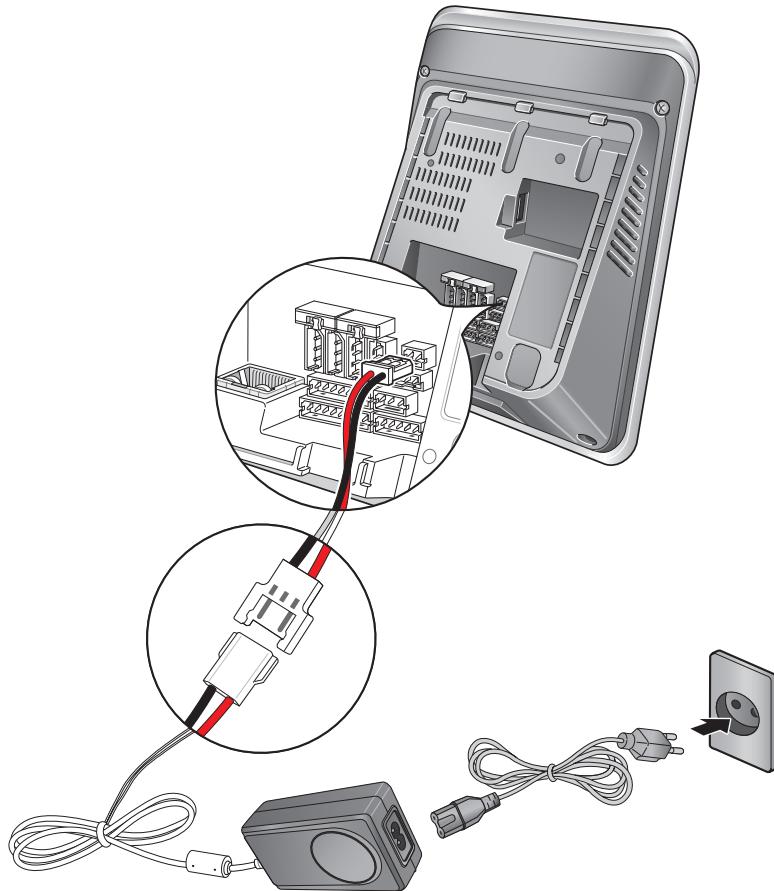

Note

- Use a 12VDC $\pm 10\%$, 1500 mA, IEC/EN 60950-1 certified power adapter.
- It is recommended not to share FaceStation's power with other devices such as Secure/I/O and/or locks.

Wireless LAN Connection

Wireless LAN FaceStation models come pre-installed with a USB WLAN module.

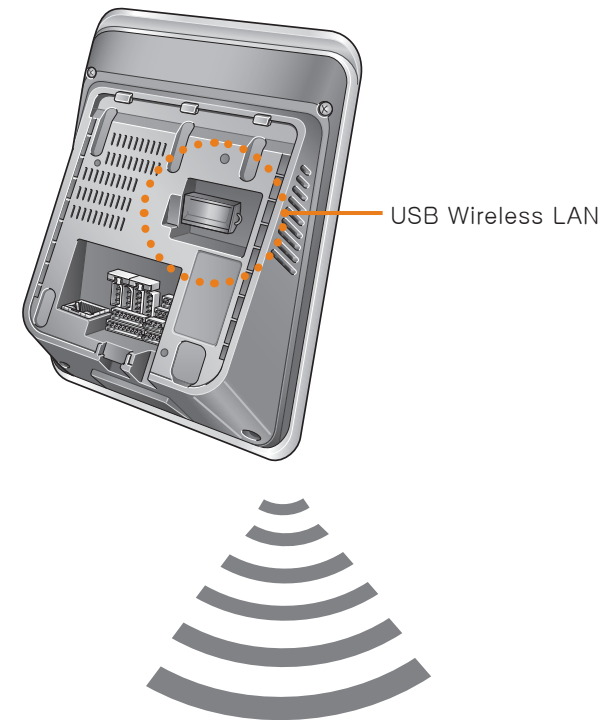

Note

- The performance of WLAN is greatly affected by the surroundings and the type of the access point (AP) used.
- Compatibility issues may cause connection difficulties with some wireless access point brands.

Ethernet Connections

Connecting with a PC

FaceStation can communicate with a PC through a direct connection using an Ethernet cable.

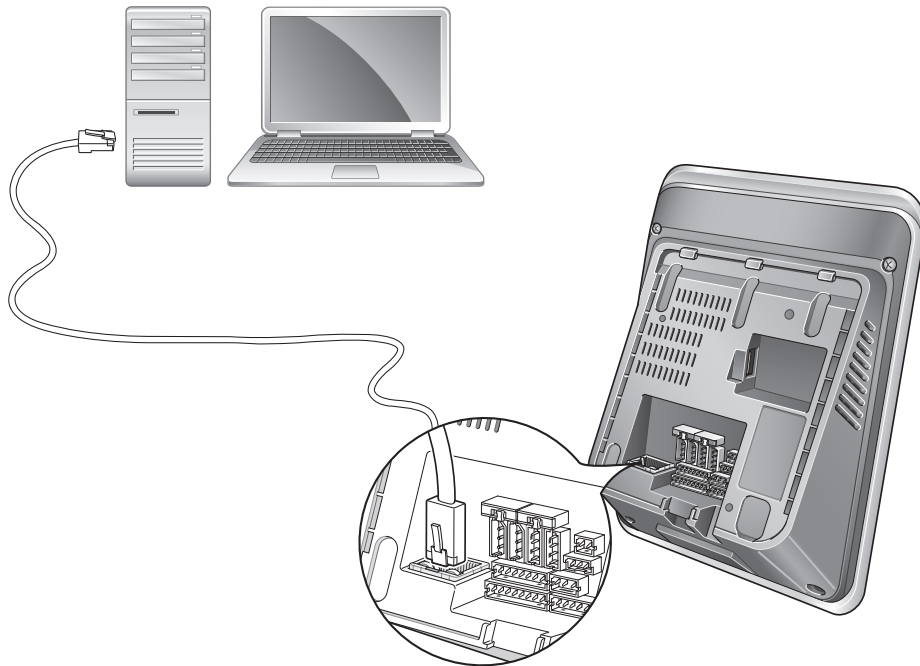

Connecting with Hub

FaceStation can be connected to a network using a regular Ethernet hub or PoE hub. PoE (Power over Ethernet): Power is provided through the Ethernet connection by an IEEE802.3af compliant PSE (Power Sourcing Equipment).

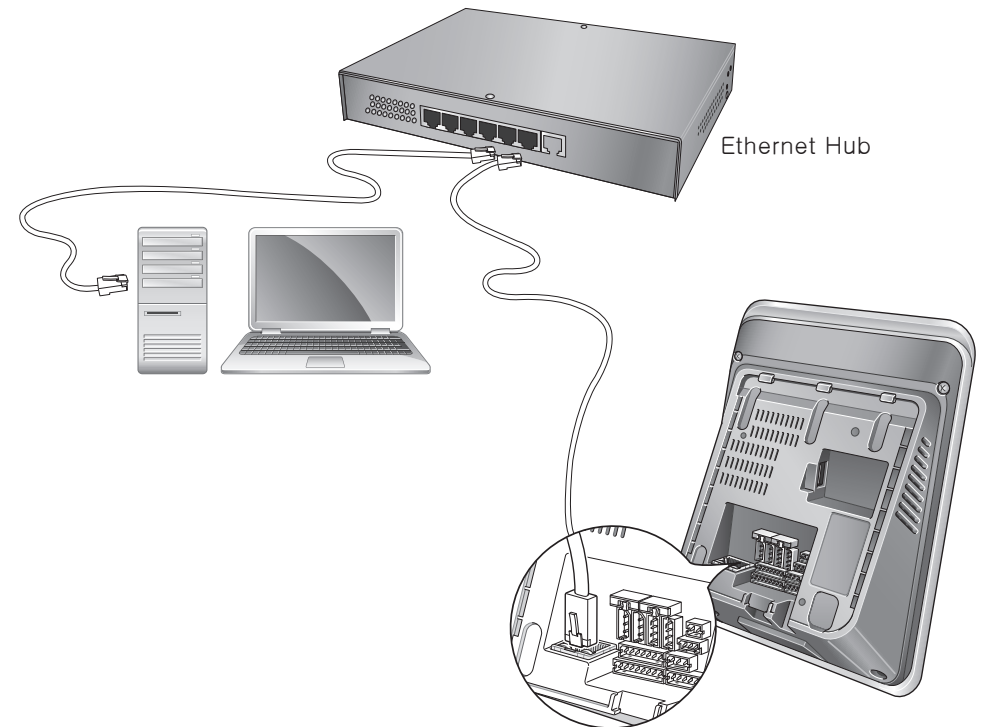

Connections

RS485 Connections

FaceStation can communicate with a PC, Secure I/O, or other devices via an RS485 connection.

Connecting with a PC

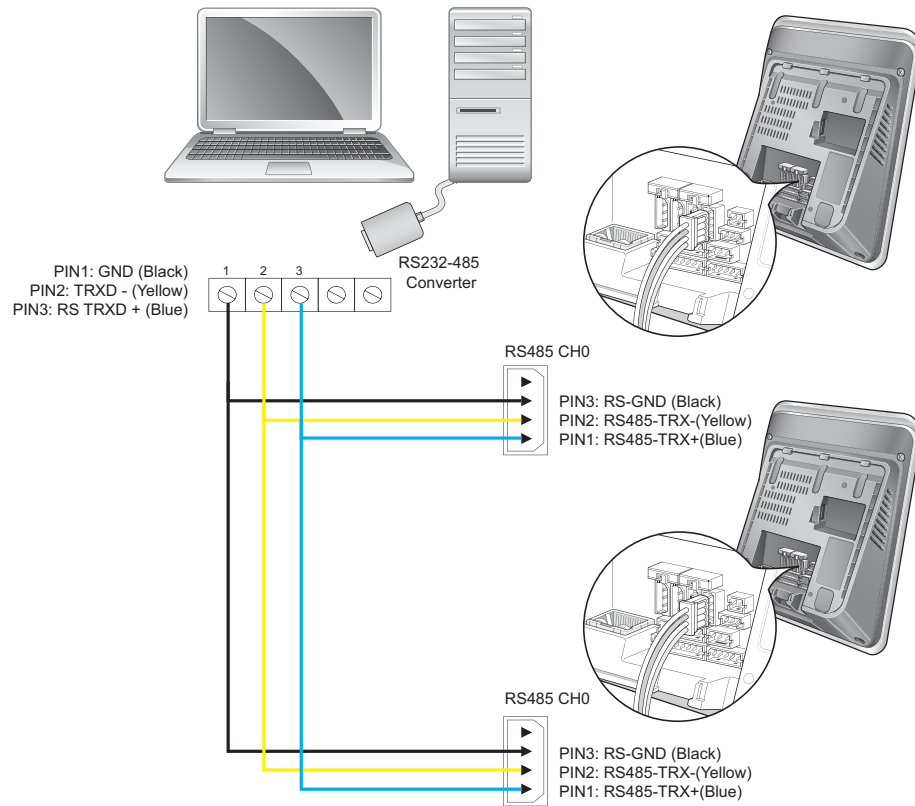

Connecting with Secure I/O

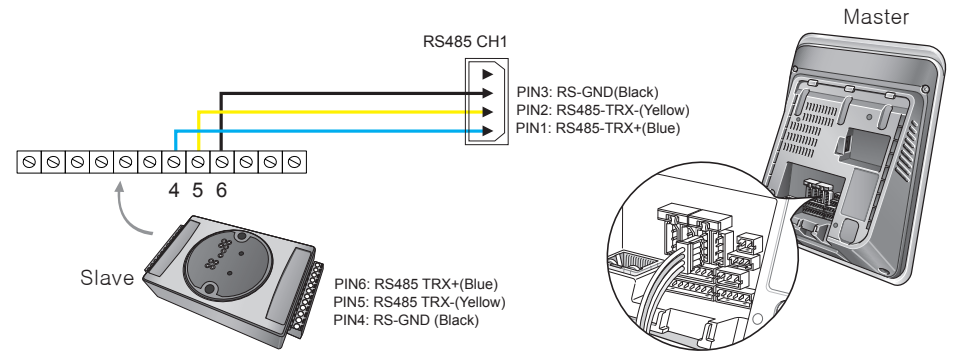

Note

- For added security, a Secure I/O is recommended as the door relay interface.

Connecting with Other Devices

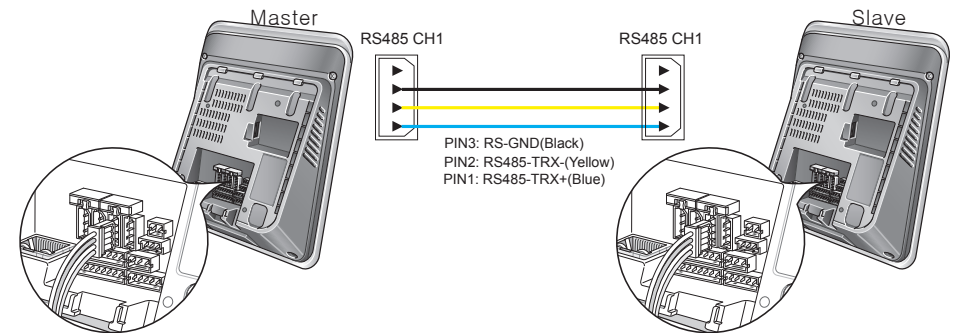

☰ Note

- For long RS485 connections, enable the dip switch to terminate the line and prevent signal degradation.

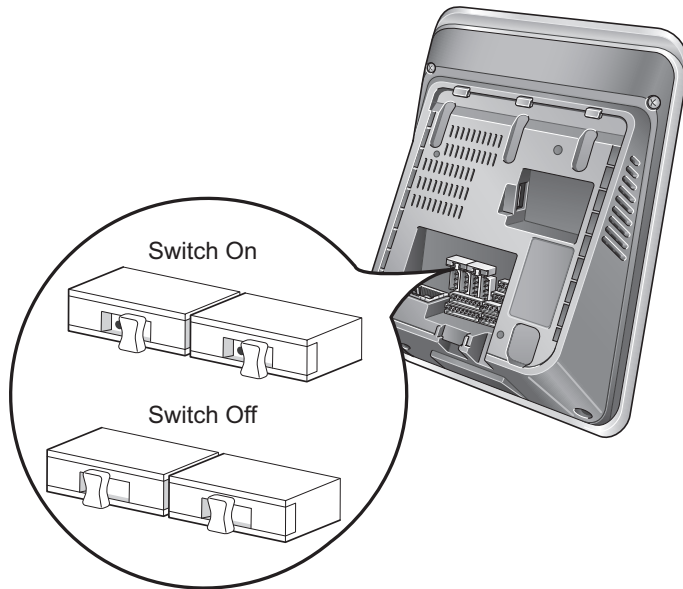

- Do not use the termination for short RS485 connections.
- If GND is not connected, the RS485 chip may malfunction.
- RS485 communication can support 2 host device and up to 7 slave devices.
- A maximum of 4 Secure I/O can be connected to one FaceStation.

RS232 Connection

FaceStation can communicate with a PC via an RS232 connection.

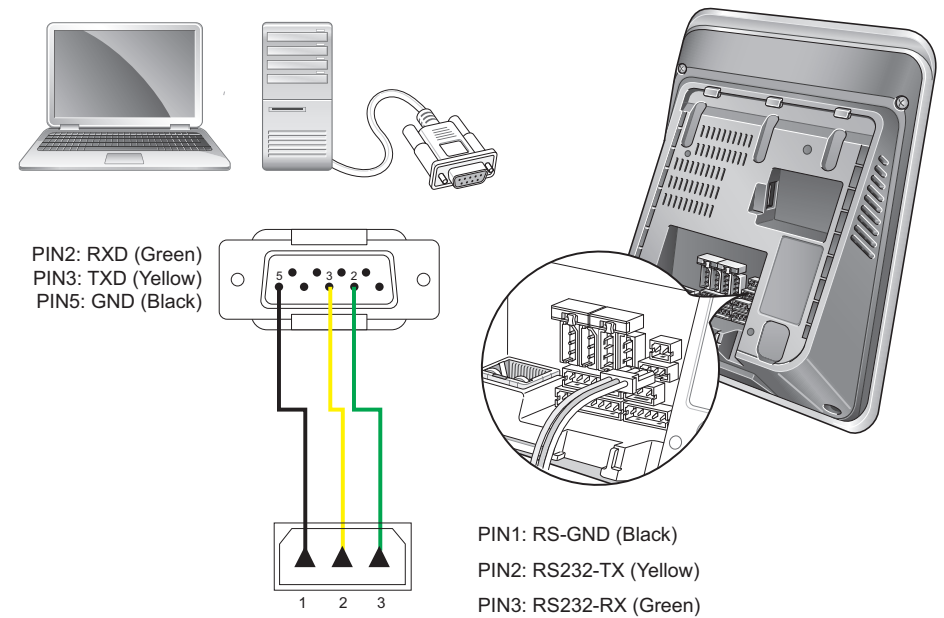

Connections

Relay Connections

Connecting with a Fail Safe Lock

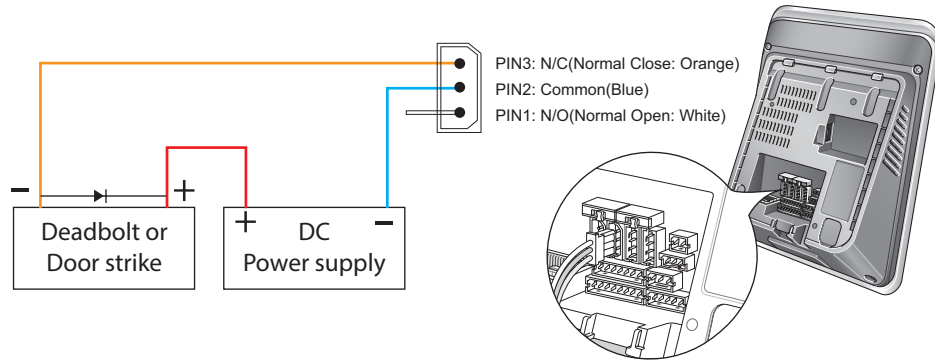

Connecting with a Fail Secure Lock

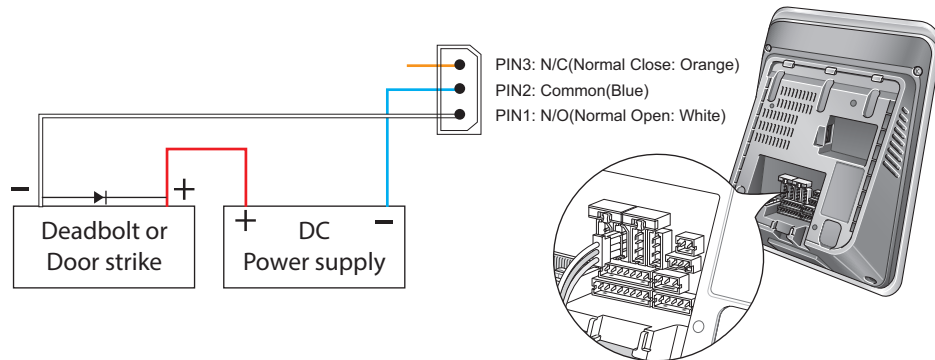

Note

- N.O. (Normally Open): A control signal closes the circuit.
- N.C. (Normally Closed): A control signal opens the circuit.

Connecting with Automatic Doors

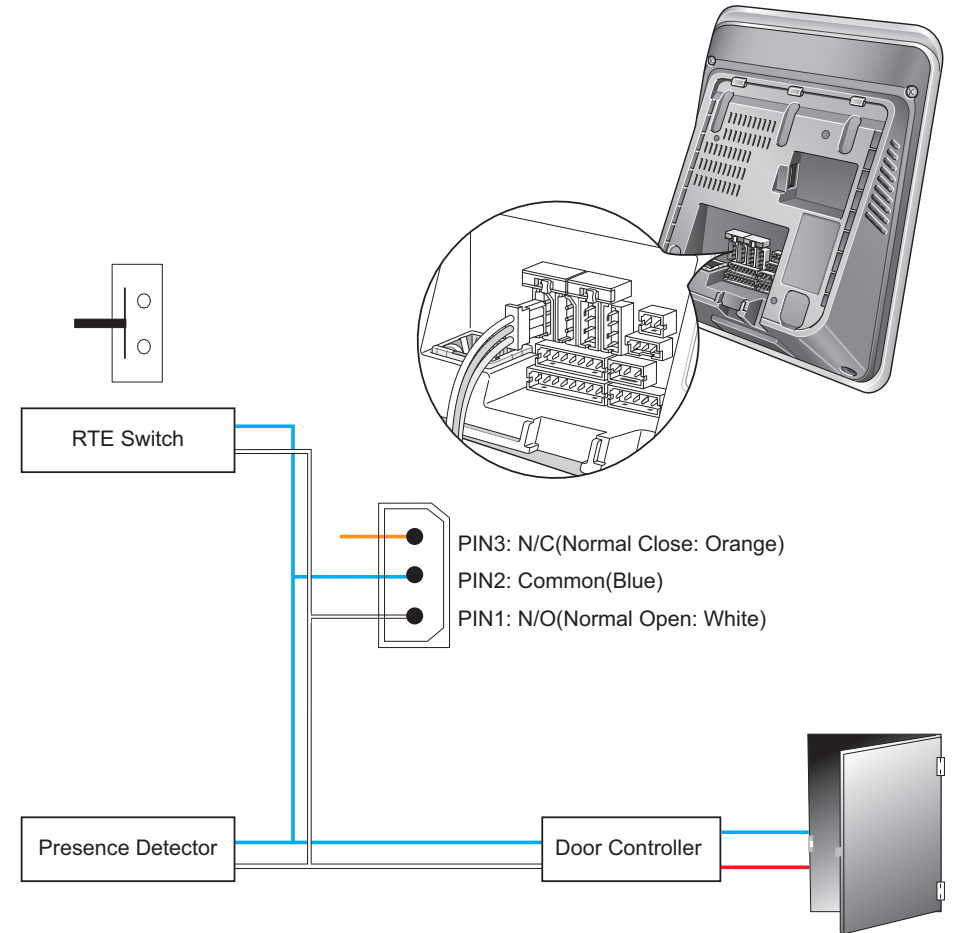

Input Connection

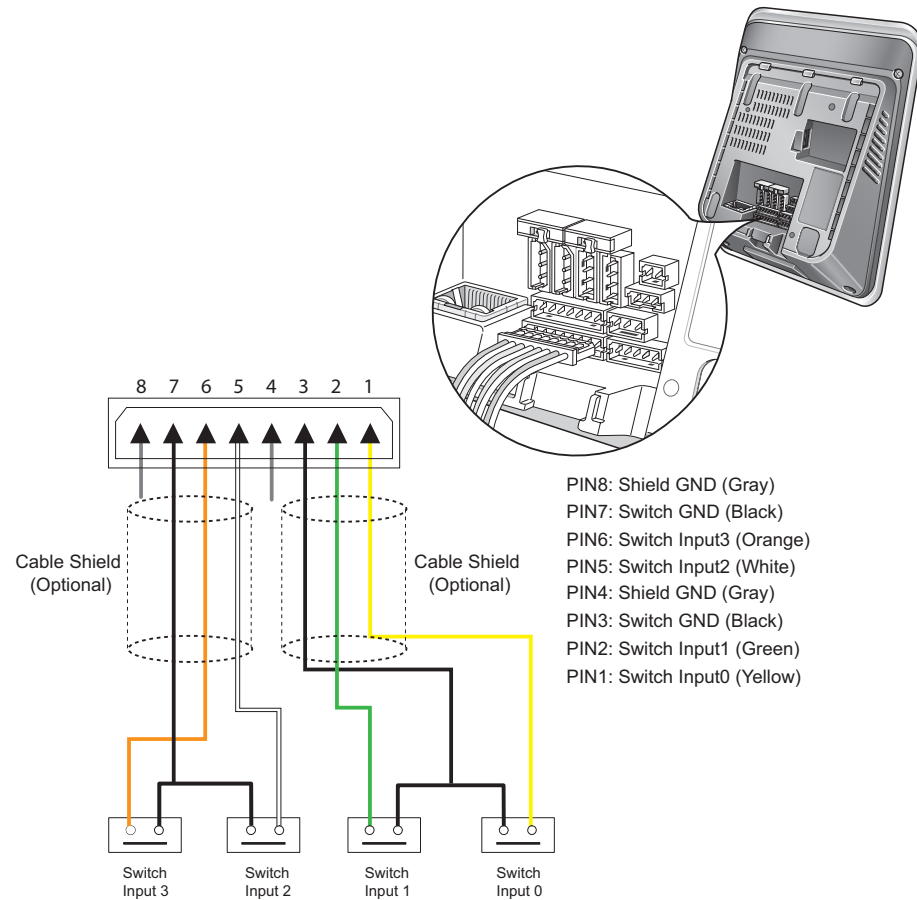

Wiegand Connections

Connecting a Wiegand Input

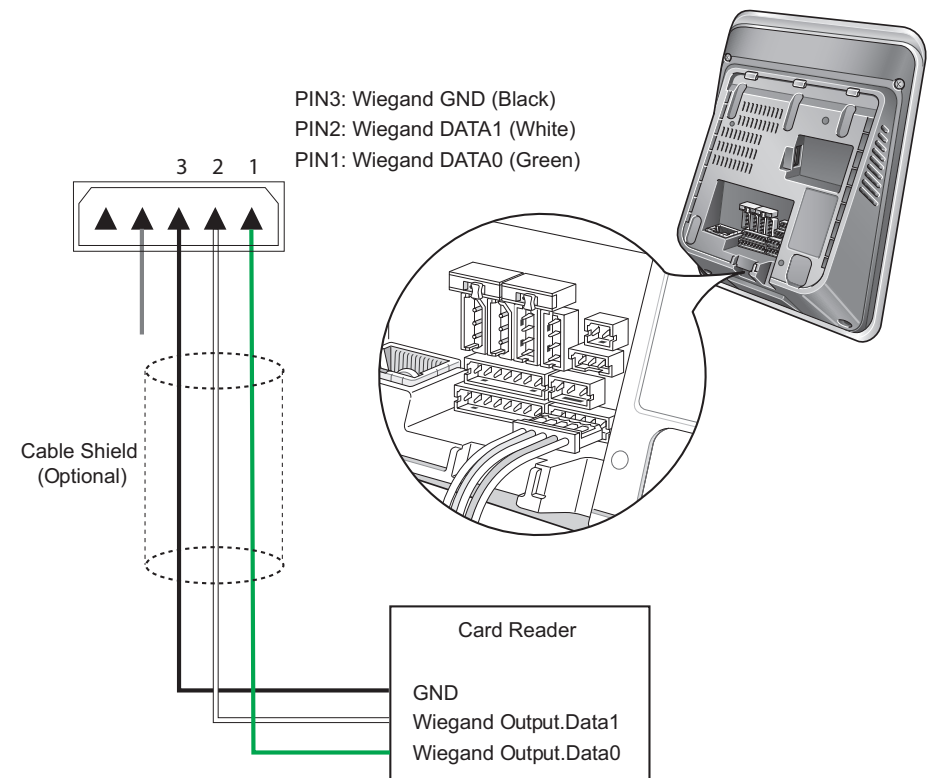

Note

- The Wiegand port can be set as either input or output via the BioStar software.

Connections

Connecting a Wiegand Output

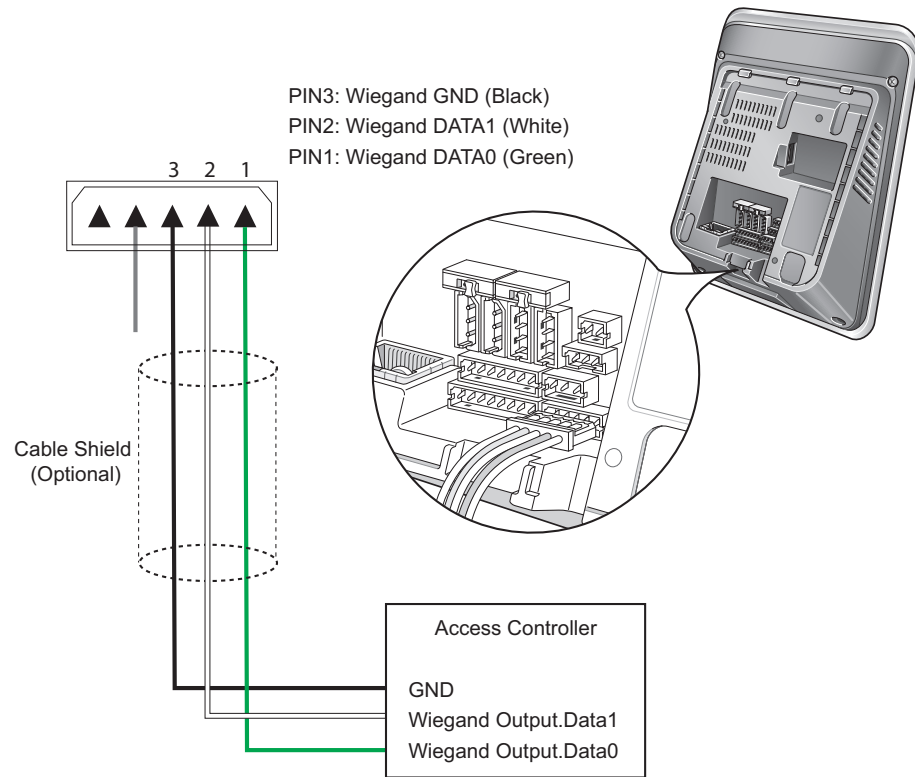

Mini USB Connection

FaceStation can communicate with a PC via the mini USB port.

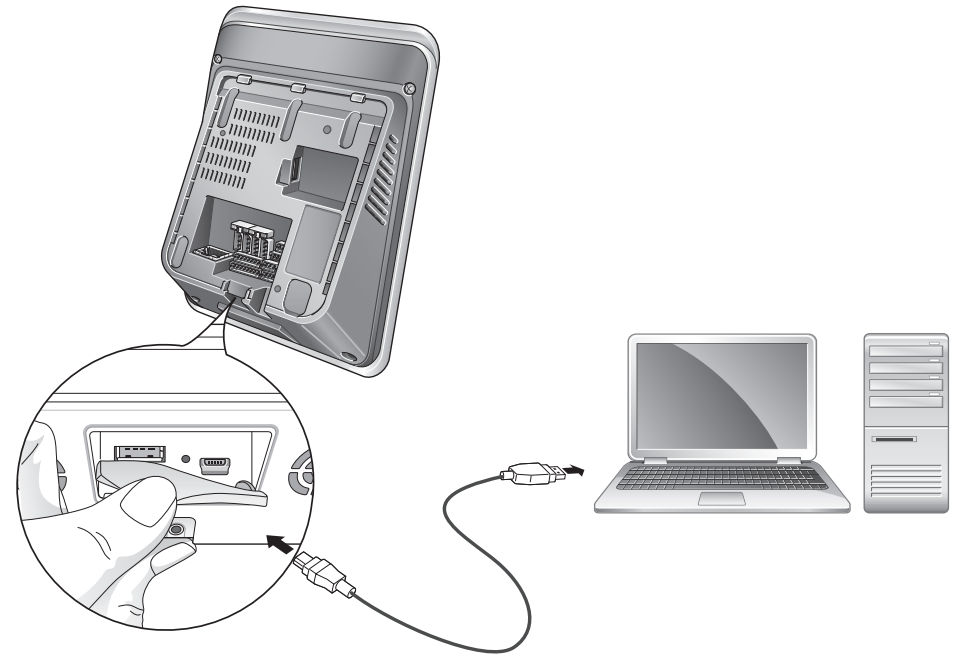

USB Connection

The USB port can be used to upload/download data to/from a USB memory device.

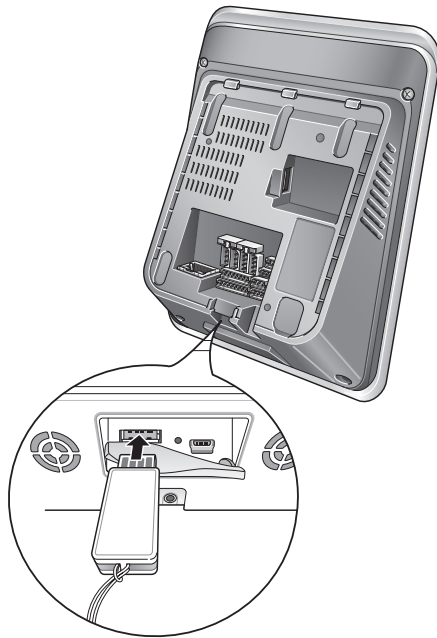

Note

- Compatibility issues may cause recognition difficulties with some USB memory devices.

Analogue Video Phone Connection

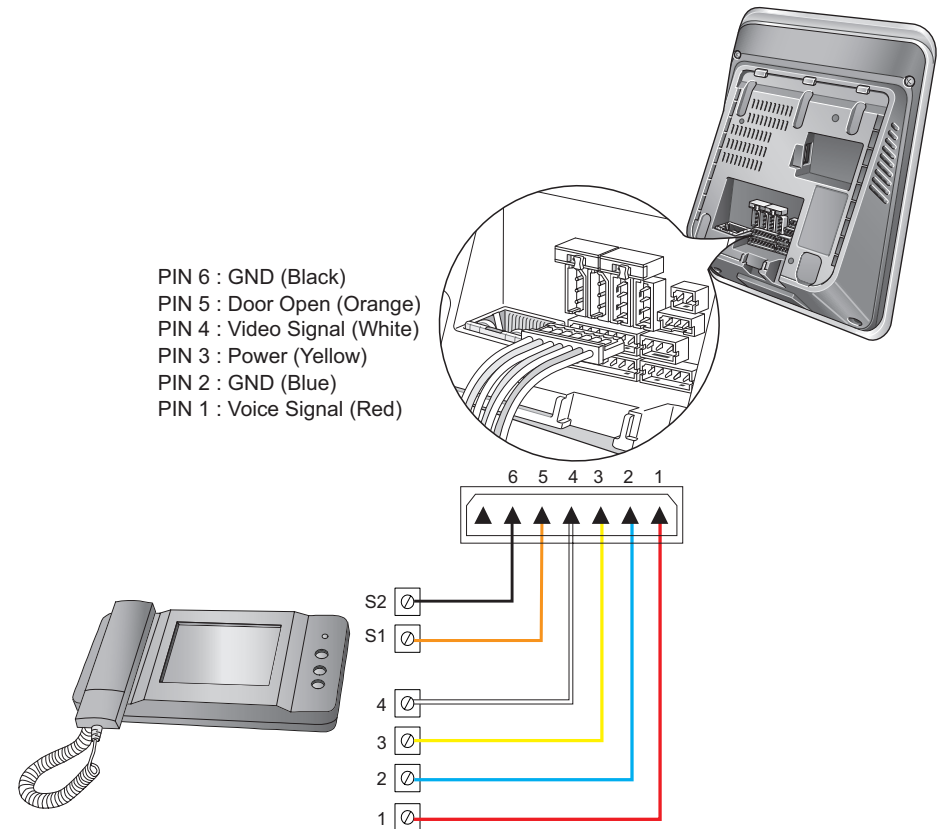

Note

- Compatible Analogue Video Phone Models:
COMMAX/ CAV-35N, COMMAX/ CAV-50H, COMMAX/ CAV-50P

4 Device Configuration

FaceStation Menu Tree

Network Settings

Operation Mode Settings

Device Settings

Display and Sound Settings

FaceStation Menu Tree

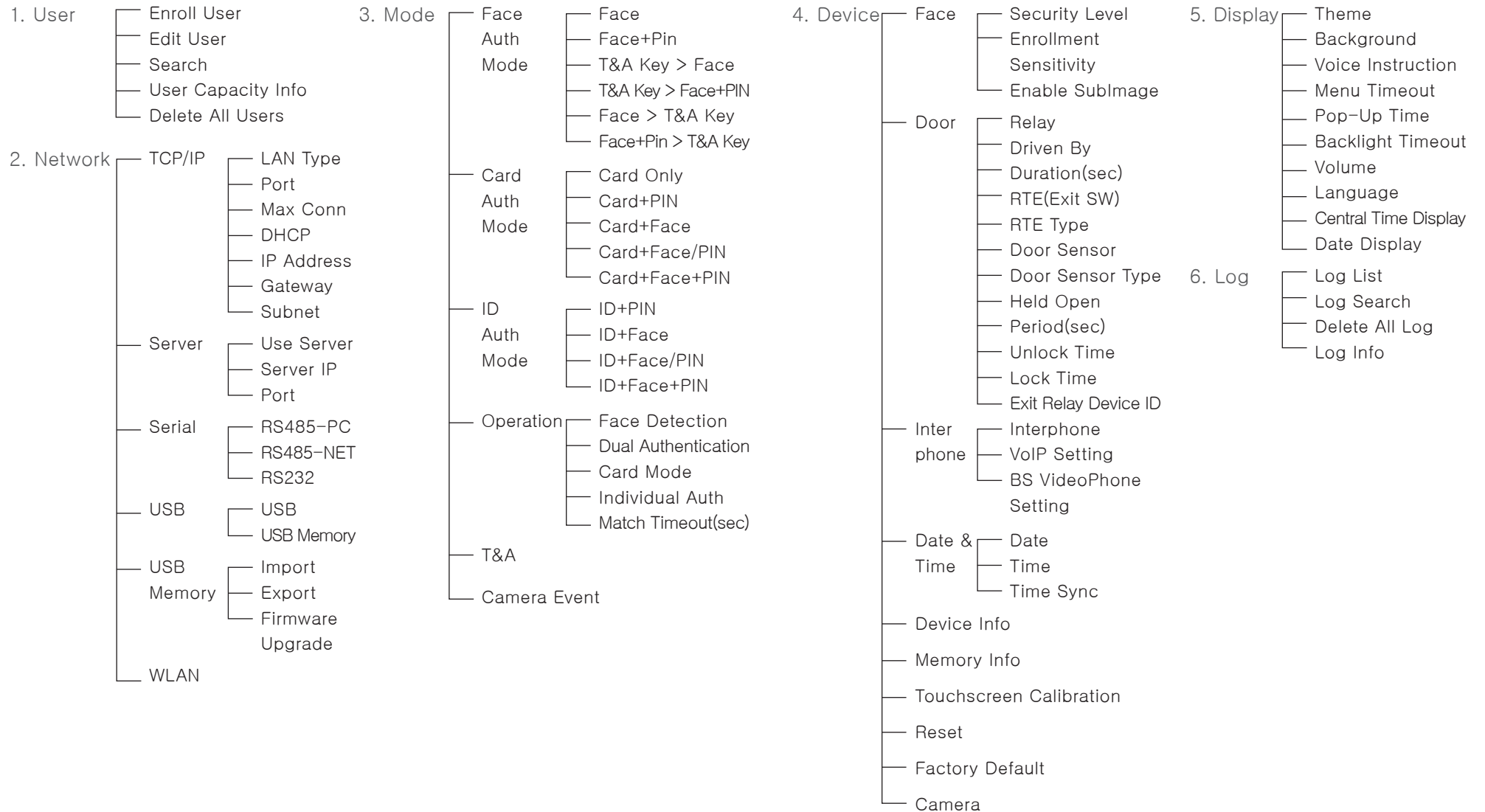

Network Settings

Setup various communication interfaces with the device.

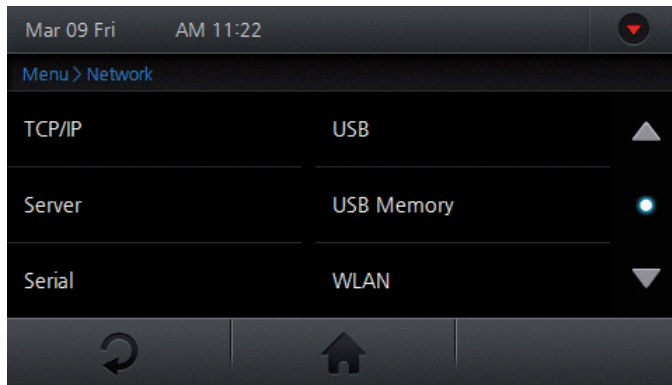

- 1 Go to **Menu > Network**.
- 2 Navigate to the desired interface.
- 3 Press to go to the previous screen or to go to the Home screen.

Setting TCP/IP

Setup the TCP/IP network settings of the device.

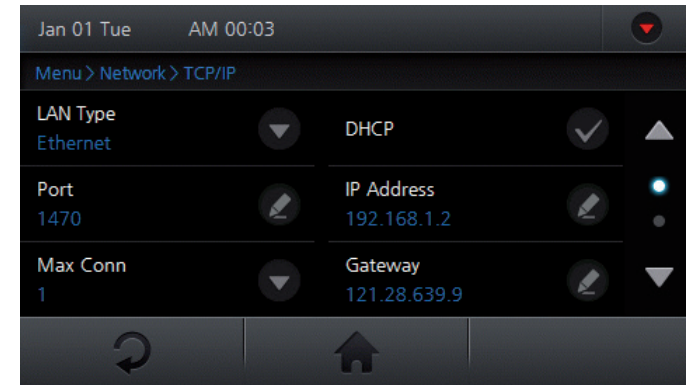

- 1 Go to **Menu > Network > TCP/IP**.
- 2 Set the options.
 - **LAN Type** Select the net type and press **OK**.
 - **Port** Enter the port and press **OK**.
 - **Max Conn** Set the maximum number of clients to be concurrently connected with the device and press **OK**.
 - **DHCP** Check to enable DHCP.
 - **IP Address** Enter the desired IP address and press **OK**. (Only available with DHCP disabled)
 - **Gateway** Enter the desired gateway address and press **OK**. (Only available with DHCP disabled)
 - **Subnet** Enter the desired subnet address and press **OK**. (Only available with DHCP disabled)
- 3 Press to go to the previous screen or to go to the Home screen.

Setting Server

Setup the TCP/IP settings of the server to be connected with the device.

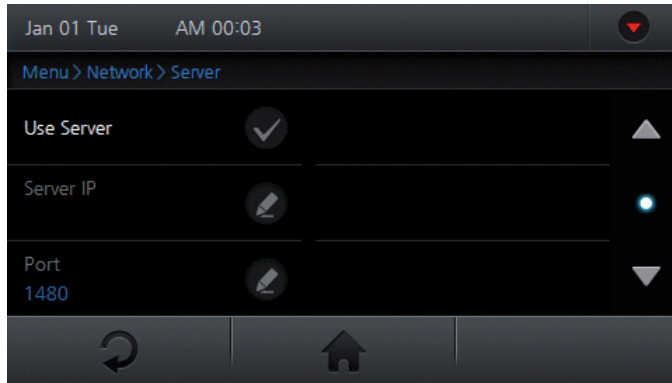

- 1 Go to **Menu > Network > Server**.
- 2 Set the options.
 - **User Server** Check to use the "Server mode".
 - **Server IP** Enter the server's IP address and press **OK**. (Only available if **User Server** is enabled)
 - **Port** Enter the server's port and press **OK**. (Only available if **User Server** is enabled)
- 3 Press to go to the previous screen or to go to the Home screen.

Setting Serial Communication

Setup the serial network settings of the device.

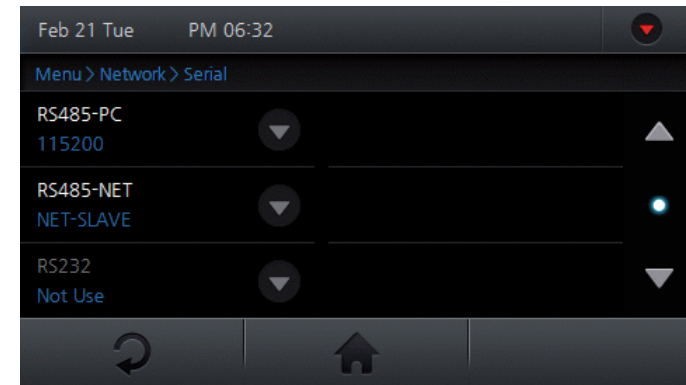

- 1 Go to **Menu > Network > Serial**.
- 2 Set the options and press **OK**.
 - **RS485-PC** You can enable/disable the RS485 port to connect with a PC and set the communication speed.
 - **RS485-NET** Set the desired RS485 communication mode. (**NET-HOST**: allows slave devices to be connect to the device; **NET-SLAVE**: allows the device to connect to a host)
 - **RS232** Set to communicate with a PC using RS232. (Only available if RS485 is disabled)
- 3 Press to go to the previous screen or to go to the Home screen.

Note

- The RS485 network supports up to 1 host devices and 7 slave devices (including up to 4 Secure I/O).

Device Configuration

Setting USB

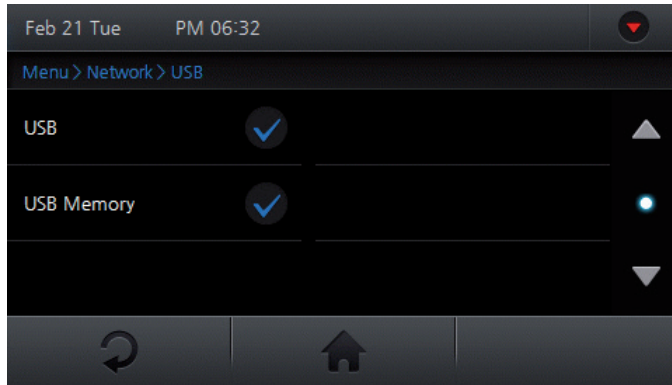

- 1 Go to **Menu > Network > USB**.
- 2 Set the options.
 - **USB** Setup the USB port to connect with a PC.
 - **USB Memory** Setup the USB port to connect with a USB memory device.
- 3 Press to go to the previous screen or to go to the Home screen.

Using USB Memory Device

Contains various options associated with the USB memory device.
(Only available if **USB Memory** is enabled)

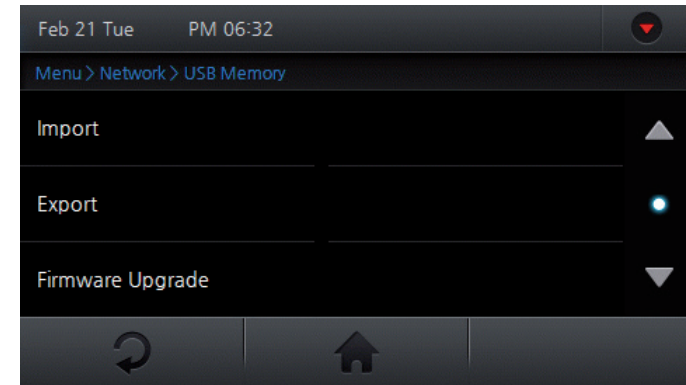

- 1 Go to **Menu > Network > USB Memory**.
- 2 Select an option.
 - **Import** Select a device ID to import data and press **OK**.
 - **Export** Press **Export** and wait until the job is completed.
 - **Firmware Upgrade** Select firmware to upgrade and press **OK**.
- 3 Press to go to the previous screen or to go to the Home screen.

Note

- The USB Memory needs to be checked from **Menu > Network > USB** in order to activate the **USB Memory** menu.

Setting WLAN (Only for wireless models)

Setup one of the four WLAN network presets to communicate with BioStar. The preset details can be configured via BioStar.

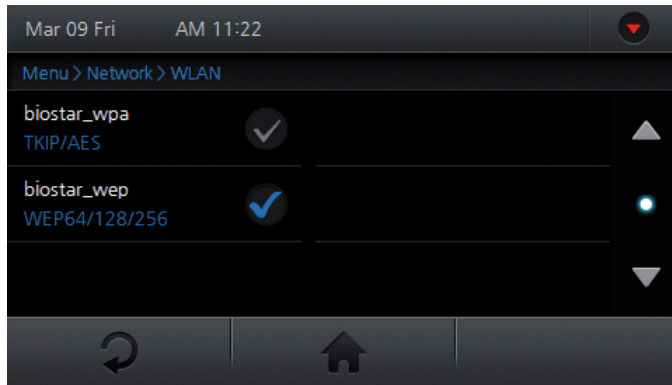

- 1 Go to **Menu > Network > WLAN**.
- 2 Check the preset option to use for WLAN connection.
- 3 Press to go to the previous screen or to go to the Home screen.

Operation Mode Settings

Setup the various authentication modes, operation modes, and/or time & attendance triggers for the device. The authentication modes will operate according to the schedule set via BioStar.

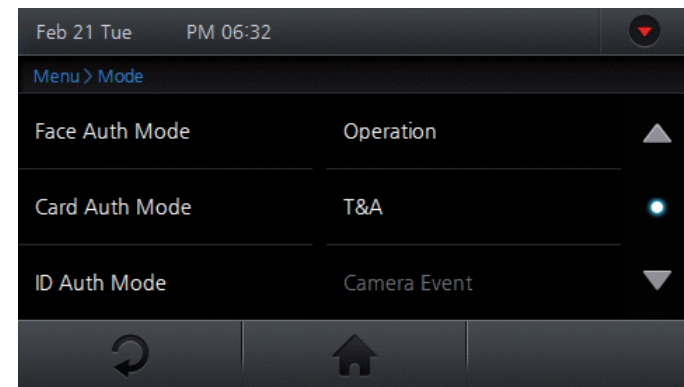

- 1 Go to **Menu > Mode**.
- 2 Set the options.
- 3 Press to go to the previous screen or to go to the Home screen.

Device Configuration

Face Authentication Mode

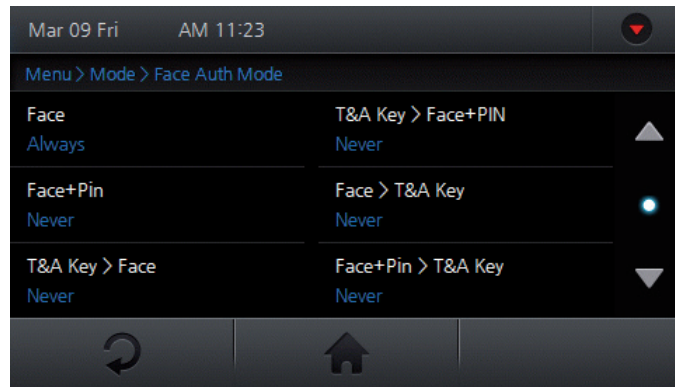

- 1 Go to **Menu > Mode > Face Auth Mode**.
- 2 Select a desired option.
 - **Face** Authenticates with a face only.
 - **Face + Pin** Authenticates with both face and pin number.
 - **T&A Key > Face** Authenticates with both the T&A key and the face.
 - **T&A Key > Face + Pin** Authenticates with the T&A key, face, and pin number.
 - **Face > T&A Key** Authenticates with both the face and the T&A key.
 - **Face + Pin > T&A Key** Authenticates with face, pin number, and the T&A key.
- 3 Check **Never** or **Always** to set the schedule.
- 4 Press to go to the previous screen or to go to the Home screen.

Card Authentication Mode

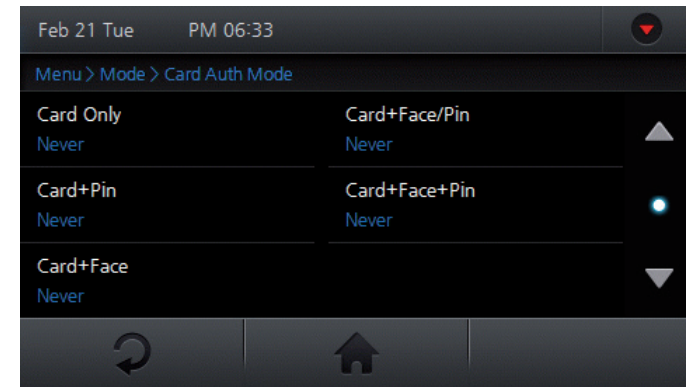

- 1 Go to **Menu > Mode > Card Auth Mode**.
- 2 Select a desired option.
 - **Card Only** Authenticates with a card only.
 - **Card + Pin** Authenticates with both card and pin number.
 - **Card + Face** Authenticates with both card and face.
 - **Card+ Face/Pin** Authenticates with both card and either face or pin number.
 - **Card + Face + Pin** Authenticates with card, face, and pin number.
- 3 Check **Never** or **Always** to set the schedule.
- 4 Press to go to the previous screen or to go to the Home screen.

ID Authentication Mode

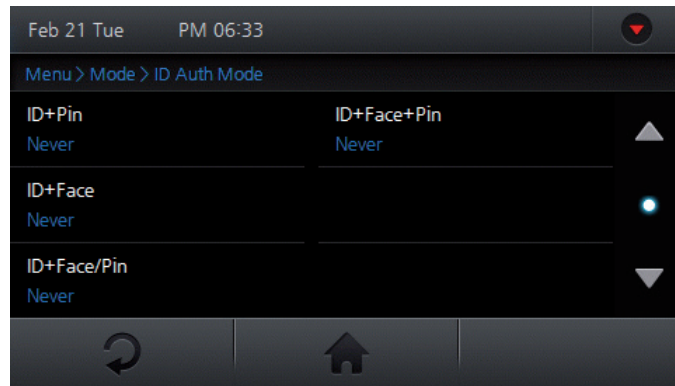

- 1 Go to **Menu > Mode > ID Auth Mode**.
- 2 Select a desired option.
 - **ID + Pin** Authenticates with both ID and pin number.
 - **ID + Face** Authenticates with both ID and face.
 - **ID + Face/Pin** Authenticates with both ID and either face or pin number.
 - **ID + Face + Pin** Authenticates with ID, face, and pin number.
- 3 Check **Never** or **Always** to set the schedule.
- 4 Press to go to the previous screen or to go to the Home screen.

Setting General Operational Parameters

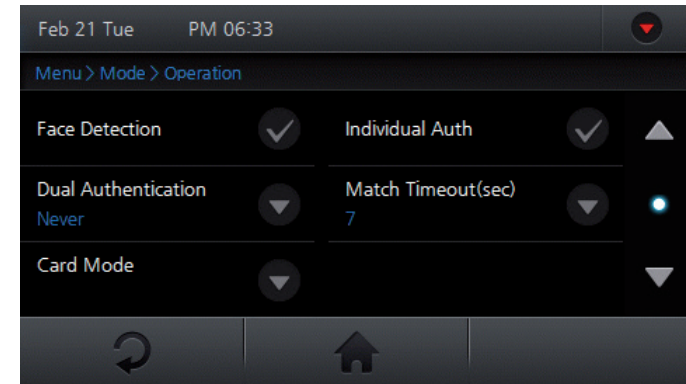

- 1 Go to **Menu > Mode > Operation**.
- 2 Check, or set the options and press **OK**.
 - **Face Detection** Check to use Face Detection. On face authentication, stores the detected face image as an image log. On ID or card authentication, additionally authenticates and stores the detected face image as an image log. If no face is detected, the authentication will end up in failure.
 - **Dual Authentication** Requires the authentication of two different users within 15 seconds and operates the associate relay.
 - **Card Mode** Select whether or not to use the CSN card for authentication.
 - **Individual Auth** Check to enable individual authentication within the device. Seer 'User Registration(page 45)' for more details.
 - **Match Timeout(sec)** Sets the time-out period for an authentication attempt.
- 3 Press to go to the previous screen or to go to the Home screen.

Device Configuration

Time and Attendance Mode

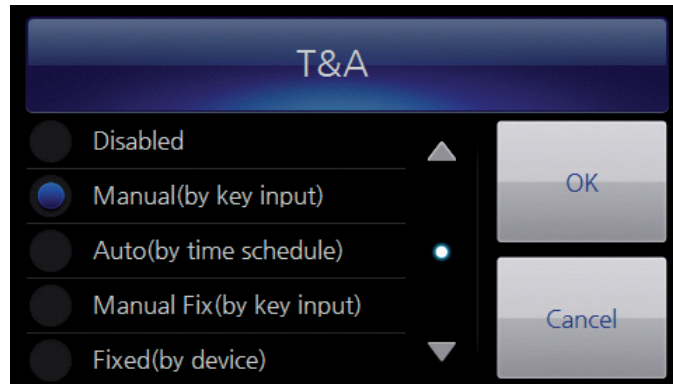

- 1 Go to **Menu > Mode > T&A > T&A**.
- 2 Set the T&A options.
 - **Disabled** Disables the T&A buttons. The Home menu and the **CALL** button remain active.
 - **Manual(by key input)** T&A events must be manually selected using the T&A buttons before authentication.
 - **Auto(by time schedule)** T&A events are automatically applied during authentication. The schedule can be created using BioStar.
 - **Manual Fix(by key input)** T&A events can be manually selected using the T&A buttons. The selected T&A event will remain until another event has been selected.
 - **Fixed(by device)** A T&A event will be fixed by the device.
- 3 Press **OK** to save the changes.
Press **Cancel** to cancel any changes.

Device Settings

Sets system related features of the device.

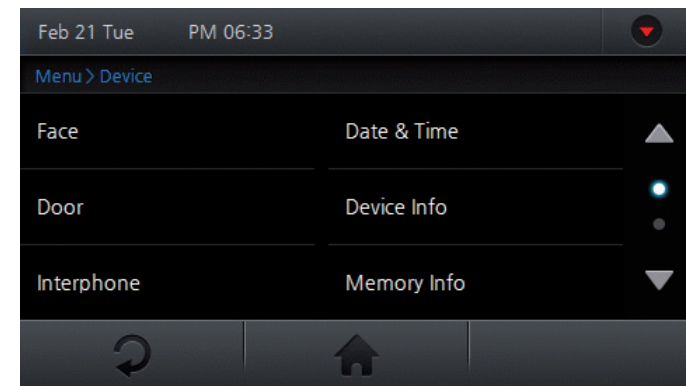

- 1 Go to **Menu > Device**.
- 2 Select the desired submenu and configure the corresponding settings.
- 3 Press **↶** to go to the previous screen or **🏠** to go to the Home screen.

Setting Face Authentication Settings

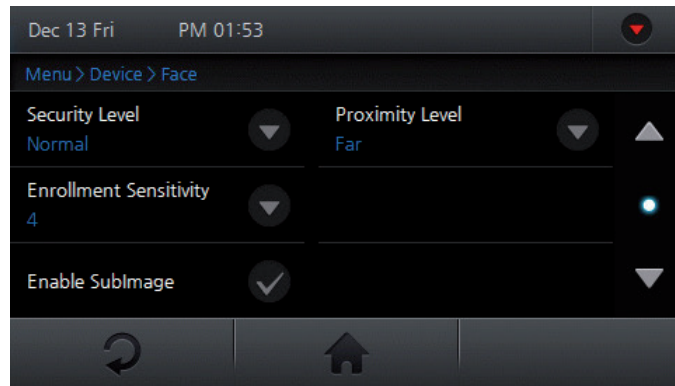

- 1 Go to **Menu > Device > Face**.
- 2 Set the options.
 - **Security Level** Select the desired security level and press **OK**.
 - **Enrollment Sensitivity** Select the desired enrollment speed and press **OK**.
 - **Enable SubImage** Check **Enable SubImage** to capture then display a thumbnail image for each newly enrolled face SubID.
 - **Proximity Level** Sets the desired level that the sensor can recognize a face according to the proximity distance. Select **Far** or **Near** and press **OK**. When the option is set to **Far**, the sensor recognition rate gets higher.
- 3 Press **↶** to go to the previous screen or **🏠** to go to the Home screen.

Note

- Increasing the security level will indirectly increase the FRR (False Rejection Rate), the probably that the system will reject access for an authorized user, because stricter authentication protocols will reject more inconsistencies.
- Decreasing the Enrollment Sensitivity will allow for easier enrollment.
- Each user can hold up to five face SubIDs, which can be used for advanced progressive enrollment for individuals with glasses or beards.

Setting Door Control

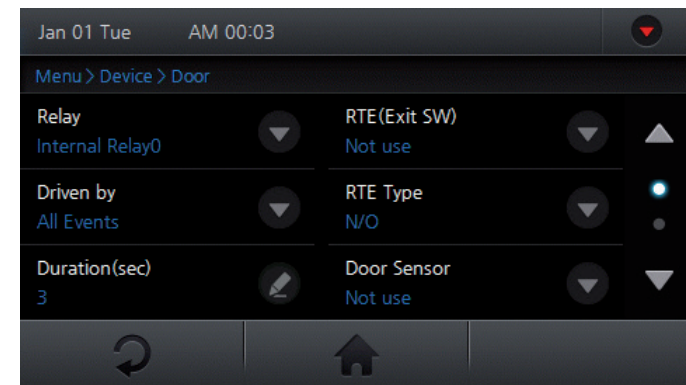

- 1 Go to **Menu > Device > Door**.
- 2 Set the options and press **OK**.
 - **Relay** Sets a relay to be used with the door.
 - **Driven by** Sets a trigger to activate the relay.
 - **All Events:** Opens the door for all authentication modes.
 - **Authentication:** Triggers the relay when a general authentication occurs.

Device Configuration

- **T&A Event:** Triggers the relay when a time and attendance authentication occurs.
- **Authentication + T&A Event:** Triggers the relay only when both general authentication and time & attendance authentication are set to trigger the relay.
- **Disabled:** Disables all triggers for the relay.
- **Duration(sec)** Sets the activation time of the relay. (Period in which the door will remain open)
- **RTE (Request to Exit)** Sets an input to be used as an exit switch.
- **RTE Type** Set the default state of the switch. (N/O: Normal Open; N/C: Normal Closed)
- **Door Sensor** Sets an input to be used for detecting the door status.
- **Door Sensor Type** Set the default state of the switch. (N/O: Normal Open; N/C: Normal Closed)
- **Held Open Period(sec)** Sets the duration that a door must be held open before an alarm is triggered.
- **Unlock Time** Sets a schedule for which the door will remain open. The schedule can be set using the BioStar software.
- **Lock Time** Sets a schedule for which the door will remain locked. The schedule can be set using the BioStar software.

3 Press ↶ to go to the previous screen or 🏠 to go to the Home screen.

Setting Interphone

Enables the device to act as an interphone.

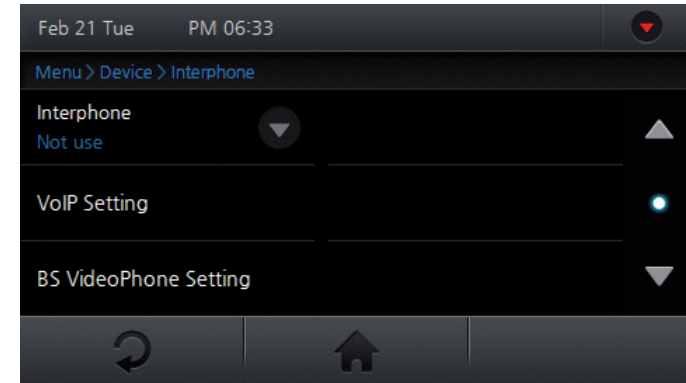

- 1 Go to **Menu > Device > Interphone**.
- 2 Select the desired interphone type and configure the corresponding settings.

Interphone Select the desired interphone type and press **OK**.



VoIP Setting

Set the desired VoIP settings for the IP Interphone.

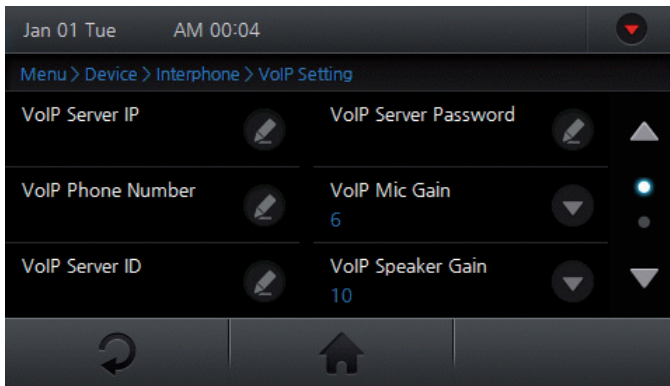

- **VoIP Server IP** Enter the VoIP IP address and press **OK**.
- **VoIP Phone Number** Enter the VoIP phone number and press **OK**.
- **VoIP Server ID** Enter a VoIP server ID and press **OK**. Korean, English, number, and special characters can be used for an ID.
- **VoIP Server Password** Enter the VoIP server password and press **OK**.
- **VoIP Mic Gain** Adjusts the VoIP microphone volume. (0 – 10)
- **VoIP Speaker Gain** Adjusts the VoIP speaker volume. (0 – 10)
- **VoIP Display Name** Enter the VoIP name to be displayed on the screen and press **OK**.

BS VideoPhone Setting

Set the desired BioStar VideoPhone settings.

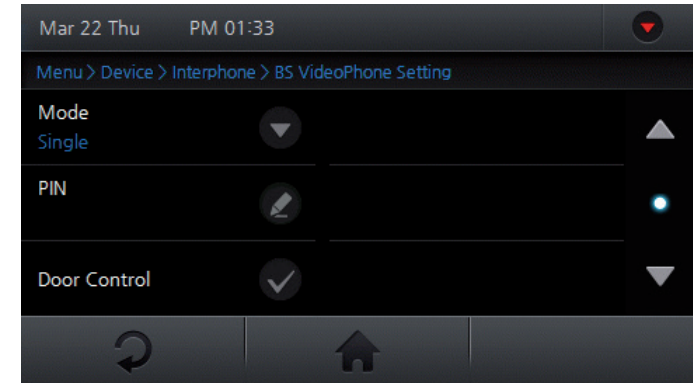

- **Mode** Select either single or extension mode and press **OK**.
- **PIN** Enter a pin number for the BioStar VideoPhone and press **OK**.
- **Door Control** Enables or disables the door control on the BioStar VideoPhone.

3

Press to go to the previous screen or to go to the Home screen.

Device Configuration

Setting Time

Sets the date/time options for the device.

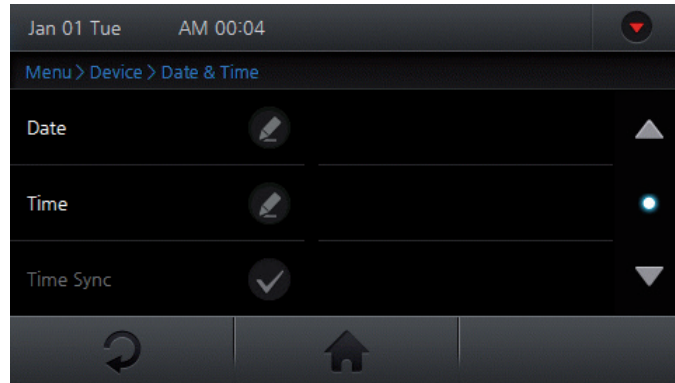

- 1 Go to **Menu > Device > Date & Time**.
- 2 Set the options.
 - **Date** Set the year, month, and day, and press **OK**.
 - **Time** Set AM/PM, hour, minute, and second, and press **OK**.
 - **Time Sync** Synchronizes the time on the device with the BioStar server. (Only available in "Server Mode")
- 3 Press **↶** to go to the previous screen or **🏠** to go to the Home screen.

Checking Device Information

Displays information such as the model name, device ID, hardware version, firmware version, kernel version, MAC address and more.

- 1 Go to **Menu > Device > Device Info**.
- 2 Press **↶** to go to the previous screen or **🏠** to go to the Home screen.

Checking Memory Status

Display the status of the DRAM, FLASH and FLASH2 memory.

- 1 Go to **Menu > Device > Memory Info**.
- 2 Press **OK** to return to the previous screen.

TouchScreen Calibration

Recalibrates the touchscreen to coordinate the point of contact with the user interface.

- 1 Go to **Menu > Device > Touch Calibration**.
- 2 Press the center of each point until the completion message appears.

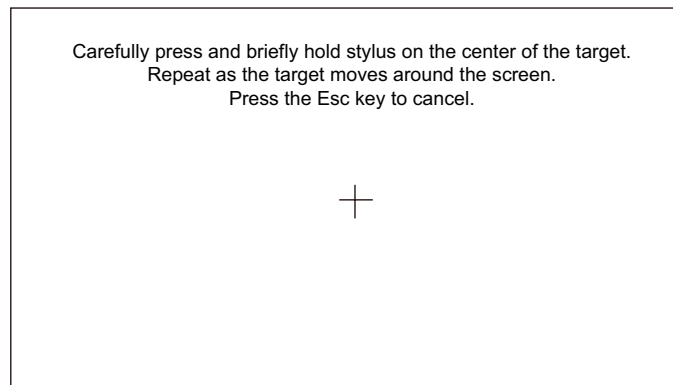

- 3 Press **OK** to complete the touchscreen calibration.

Note

- There is no "Esc" key so the process must be completed to exit the touchscreen calibration.

Device Reset

- 1 Go to **Menu > Device > Reset**.
- 2 Press **Yes** to restart the device.
Press **No** to return to the previous screen.

Factory Default

- 1 Go to **Menu > Device > Factory Default**.
- 2 Press **Yes** to initialize the device.
Press **No** to return to the previous screen.

Note

- A factory default will only affect the device configurations. The user information and log data will remain intact.

Camera

- 1 Go to **Menu > Device > Camera > Power Line Frequency**.
- 2 Select the corresponding power line frequency setting.
- 3 Press **OK** to save the setting.
Press **Cancel** to cancel the setting.

Note

- Make sure to set the correct power line frequency to avoid the image flickering.

Display and Sound Settings

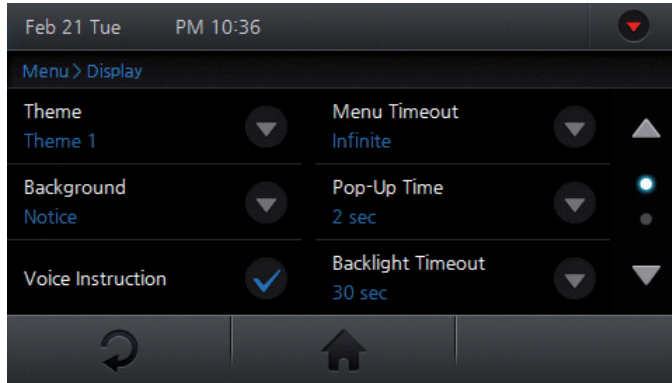

- 1 Go to **Menu > Display**.
- 2 Set or check by pressing the relevant option.
- 3 Press to go to the previous screen or to go to the Home screen.

Theme

Sets the graphical theme of the device.

Select among **Red**, **Blue**, **Black**, **Rainbow**, and **Custom**, and press **OK**.

Background

Sets the background of the device.

Select among **Logo**, **Notice**, **Slide Show**, and **PDF**, and press **OK**.

Note

- The Logo screen is displayed during authentication.

Voice Instruction

Enables voice instructions from the device.

Menu Timeout

Sets the amount of idle time required before returning to the home menu.

Select among **Infinite**, **10 sec**, **20 sec**, and **30 sec**, and press **OK**.

Pop-Up Time

Sets the duration before the pop-up window disappears.

Select among **0.5 sec**, **1 sec**, **2 sec**, **3 sec**, **4 sec**, and **5 sec**, and press **OK**.

Backlight Timeout

Sets the amount of idle time required before turning off the LCD.

Select among **Infinite**, **10 sec**, **20 sec**, **30 sec**, **40 sec**, **50 sec**, and **60 sec**, and press **OK**.

Volume

Sets the volume output of the device.

Select among **0**, **10**, **20**, **30**, **40**, **50**, **60**, **70**, **80**, **90**, and **100**, and press **OK**.

Language

Sets the displayed language on the device.

Select among **Korean**, **English**, and **Custom**, and press **OK**.

Central Time Display

Enable or disables the clock located in the center of the screen.

Date Display

Sets the desired date format.

Select **MM/DD** or **DD/MM**, and press **OK**.

Authentication Alert

Enables or disables the authentication alert that is outputted when the face authentication screen is displayed. When the authentication alert is enabled and the face authentication screen is displayed, corresponding alert sounds for an authentication mode is outputted. When the authentication alert is disabled and the face authentication screen is displayed, a beep is outputted.

5 Device Operation

Basic Screen Views

User Management

Authentication Modes

Viewing Logs

Basic Screen Views

Face Authentication Screen

The following screen is displayed during face authentication.



1	Home	Goes to the Home screen.
2	ID	Goes to the ID authentication screen.
3	T&A	Selects Time and Attendance options.
4	Menu	Goes to the Administrator's menu.
5	Face Detection Icon	Displays the face detection status.
6	Image Display Screen	Displays an image from the camera.
7	Authentication Method	Displays the authentication method.
8	T&A Event	Displays the current T&A mode.
9	Current Time	Displays the current time on the device.
10	Face Detection Guide Line	Displays the guide line for face detection. (Blue circle: Face Detected/ Orange: Face Not Found)

Home Screen

The following screen is the default home screen.

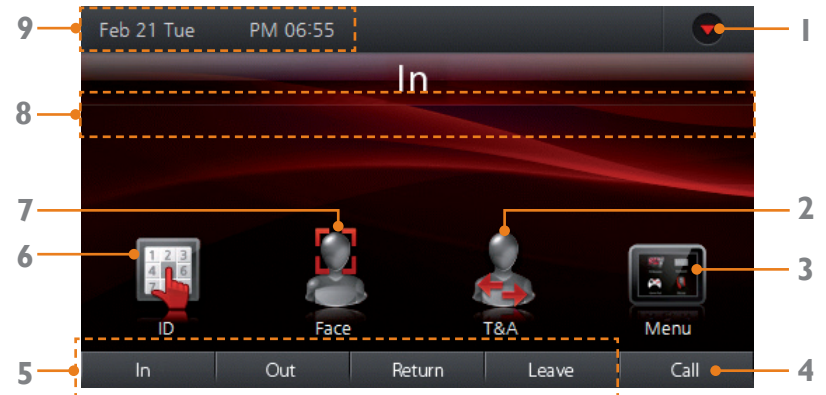

1	Status Button	Click to display the status of the device.
2	Additional T&A Button	Click to select up to 12 time & attendance options in addition to the 4 basic time & attendance buttons.
3	Menu Button	Click to enter the administrator menu.
4	Call Button	Click to use the selected video phone.
5	Basic T&A Button	Displays 4 basic time & attendance events
6	ID Authentication Button	Click to initiate the ID authentication mode.
7	Face Authentication Button	Click to initiate the face authentication mode.
8	T&A Event	Displays the current T&A mode.
9	Status Bar	Displays the date and time on the device.

Device Operation

Device Status Screen

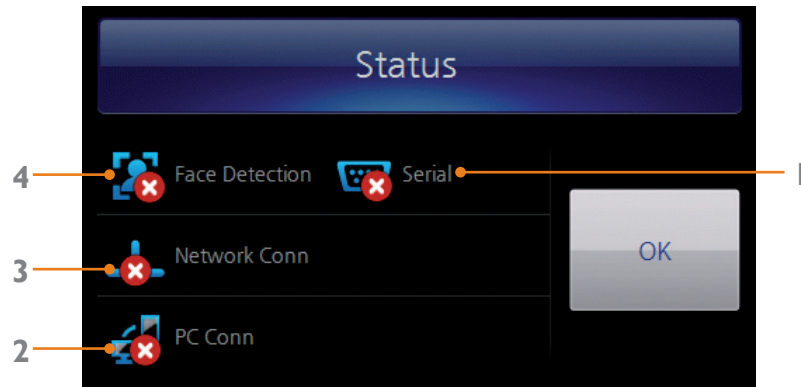

1	Serial	Displays the connection status with a host when in RS485 slave mode.
2	PC Connection	Displays the connection status with a PC through Ethernet or WLAN.
3	Network Connection	Displays the connection status of the Ethernet or WLAN.
4	Face Detection	Displays whether or not the face recognition is enabled.

Note

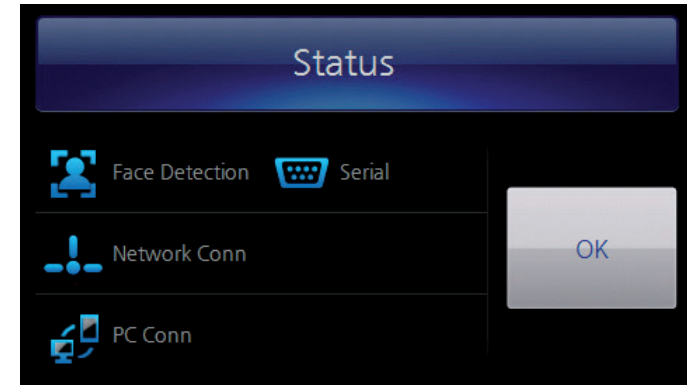

When the face recognition and all connection status are successfully set, a screen as shown above is displayed.

User Management

User Registration

After the device installation, register the administrator before use.
 Check the "Administrator" option within the enroll user window to create an administrator.
 The administrator can register and delete users and set preferences.

1) Go to **Menu > User > Enroll User**.

Register the user's picture.

- 1) Press the Profile Image for registering the user's picture.
- 2) Align your face in the screen and press **Capture**. The captured facial image will be registered.
 Press **Cancel** to cancel the registration.

2

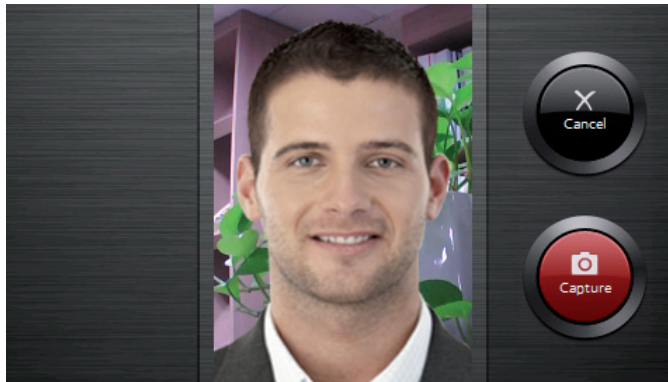

3

Press **User ID** to enter the user ID and press **OK**.

4

Press **Name**, and enter a name press **OK**.

5

Press **Face** to enroll a face.

Up to five different versions of the user's face may be enrolled.

- 1) Stare directly at the screen.

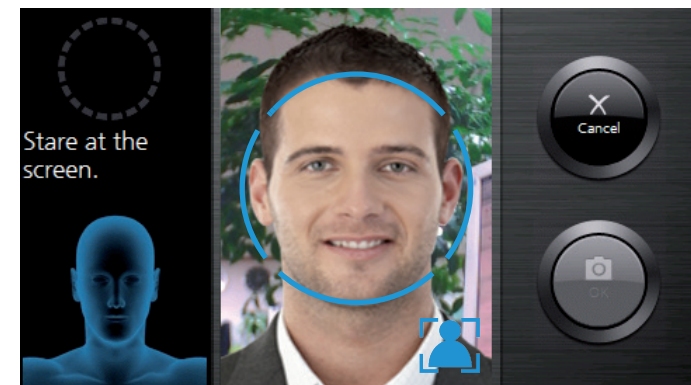
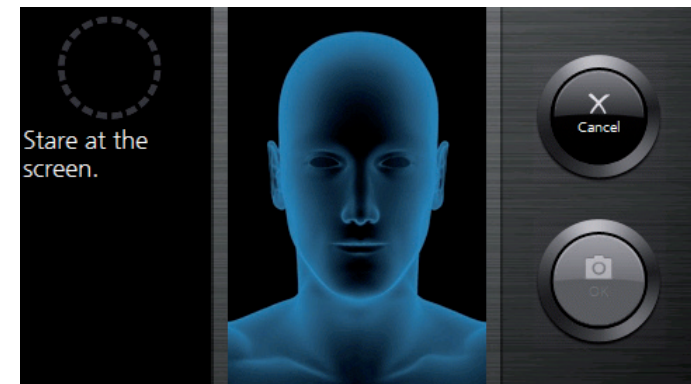

Device Operation

2) Move your head up and down.

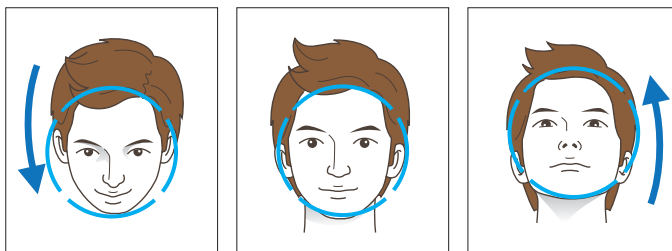
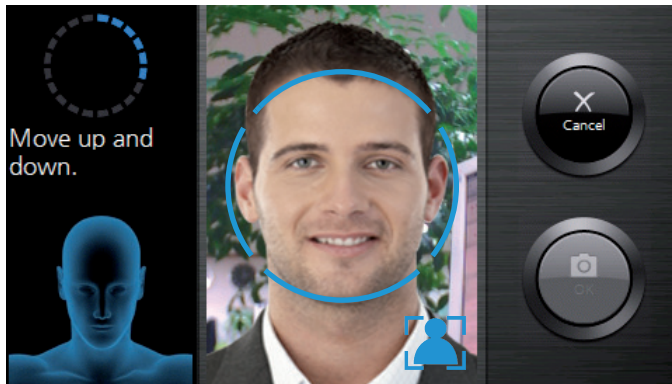
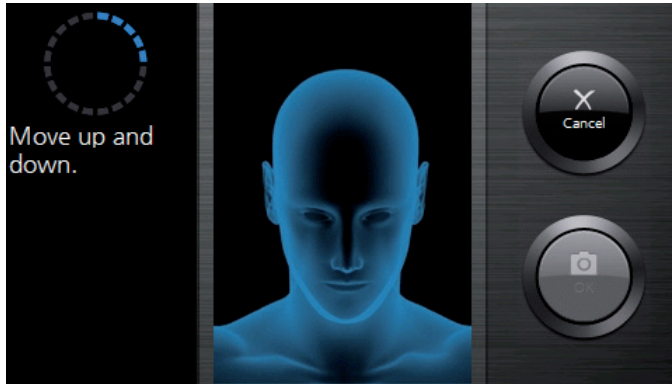

3) Move your face back and forth.

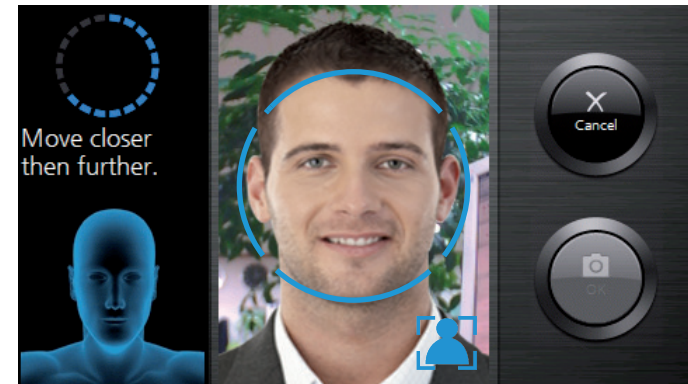

4) Move your face right and left.

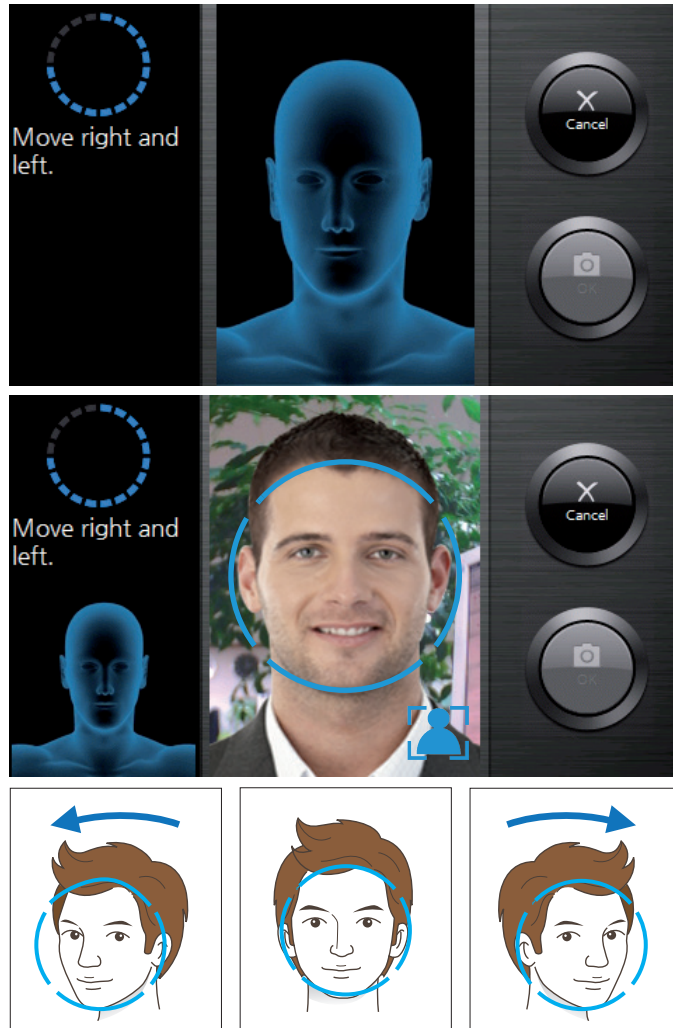

5) Press **OK** to complete the registration.
Press **Cancel** to cancel the face registration.

6) Press **Face** to enroll another version of the individual's face.

6 Press **Card** to enter the ID and press **OK**.

7 Press **PIN** to enter the pin number and press **OK**.

8 Check **Administrator** to register as the administrator.
Uncheck **Administrator** if registering as a general user.

9 Check or uncheck **Bypass Card**. If **Bypass Card** is checked when registering a user, the user is always authenticated regardless of the authentication mode on the device.



Press **Individual Auth** and set the authentication mode.

A user registered with this mode is authenticated with the individually selected authentication mode instead of the device authentication mode.

10 The set individual authentication mode works only for the relevant authentication method. For higher security, it is recommended to set either '**Card+Face**' or '**ID+Face**'. For twins, it is recommended to set either '**Card+Face**' or '**ID+Face**'. After setting the mode, press **OK**.

11 Select **Group** and set the access of group users. A group can be selected from Access groups transferred from the BioStar software to the relevant device. After setting, press **OK**.

Press . You can register a new user.

12 Press  to go to the previous screen or  to go to the Home screen without saving the changes.

Device Operation

☰ Precautions for Registration

- If there is no progress in registration, slightly move your face.
- It is recommended to register your face at the installation site.
- Register an expressionless face.
- It is recommended to keep a distance of 40~80cm from the device when registering your face.
- If a user wears glasses, you may replace step 4 "Move your face left and right" with "take off your glasses and stare directly at the screen".
- Remove any obstacles obstructing your face. The eyes and eyebrows must be exposed.
- Only one person can use the device at a time.
- Do not wear sunglasses when using the device.
- Re-enroll users that have undergone major changes in facial appearance.
- Multiple versions of an individual's face are extremely useful for individuals wearing glasses or individuals with beards.
- Individuals wearing glasses can enroll their face with and without glasses.
- Individuals with beards can progressively enroll various stages of a beard cycle. Once the beard cycle has been completed, the individual will not have to register again.

☰ Note

- If you press **Menu** while no user is registered, the administrator's menu is displayed without any authentication process.
- When a general user follows the process to enter the administrator's menu, the user can view the event log for the time and attendance.
- Regardless of a previously set authentication mode, you can move to the administrator's menu by Face authentication, Card authentication, and ID + Face/Pin authentication.

Modifying User Information

Use the following steps to modify the information of a registered user.

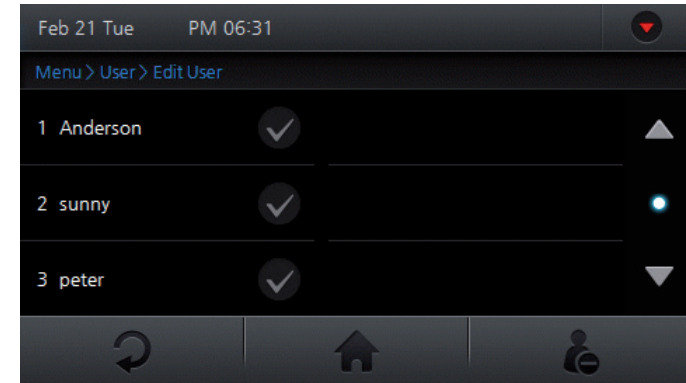

- 1 Go to **Menu > User > Edit User**.
- 2 Select a user by pressing the user name field.

Press **Face** to enroll or delete a face.

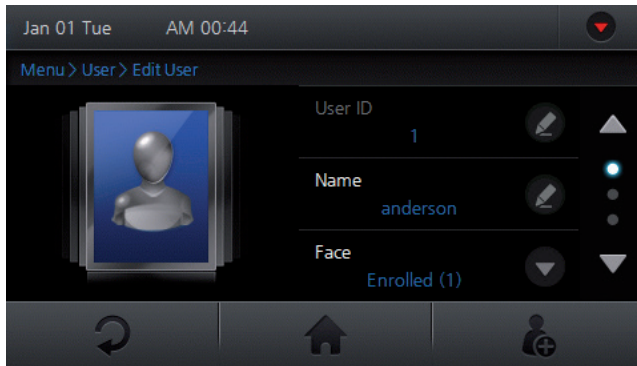

- 3 1) Press to register a new face.
For details regarding the information modification, please refer to 'Step 5 of User Registration(page 45)'.
- 2) Press to delete a face.

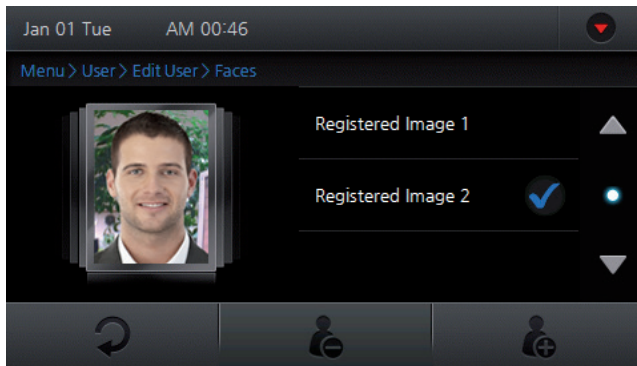

- 4 Modify the desired other information.
For details regarding the information modification, please refer to 'User Registration(page 45)'.

- 5 Press to save the modified information.
Press to go to the previous screen or to go to the Home screen without saving the changes.

Note

- The user ID cannot be modified.

Deleting a User

Use the following steps to remove user(s) from the FaceStation's database.

- 1 Go to **Menu > User > Edit User**.
 - 2 Select the user(s) to be deleted.
- Press .

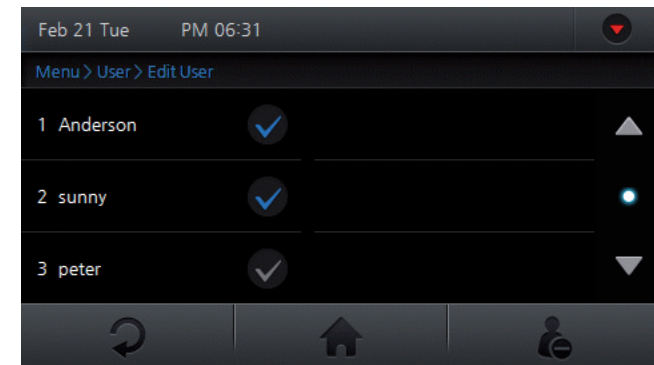

- 3
- 4 Press **Yes** to delete the selected user.
Press **No** to cancel the deletion.

Device Operation

Deleting All Users

Use the following steps to delete all the users within the database.

- 1 Go to **Menu > User > Delete All Users**.
- 2 Press **Yes** to delete all registered users.
Press **No** to cancel the deletion.

Note

- When a user is deleted while not saved on the BioStar software database, the user cannot be restored.

Searching for a User

Use the following steps to search for a registered user.

- 1 Go to **Menu > User > Search**.
- 2
 - **Search by ID** Enter an ID and press **OK**.
 - **Search by Name** Enter a name and press **OK**.
 - **Search by CSN** Enter the card.
- 3 Press **OK** to display the search results.
Press **Cancel** to cancel the search.

Checking User Capacity

Use the following steps to view the memory status of the user DB.

- 1 Go to **Menu > User > User Capacity Info**.
- 2 Press **OK** to return to the previous screen.

Note

- FaceStation can store up to 10,000 users (1:1).

Authentication Modes

FaceStation supports the face, card (RFID), and ID (PIN) authentication. The authentication mode operates according to the set timezone, and each authentication timezone does not overlap. Up to 128 timezones for setting authentication mode can be set on BioStar PC software.

Face Authentication Procedure

When **Menu > Mode > Face Auth Mode > Face** is set as **Always**, the face authentication screen automatically is activated by a user in close proximity to the device.

- Align your face within the orange guideline until it turns blue. And keep your face still until the authentication is complete.

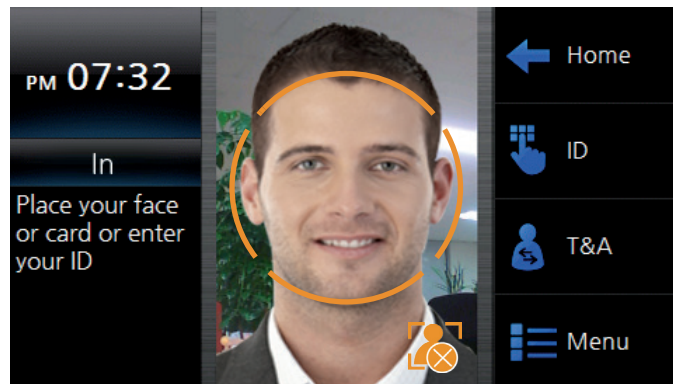

Note

- Make sure to keep the distance of 50cm from the device when authenticating the face.

- The follow screen will be displayed upon a successful authentication.

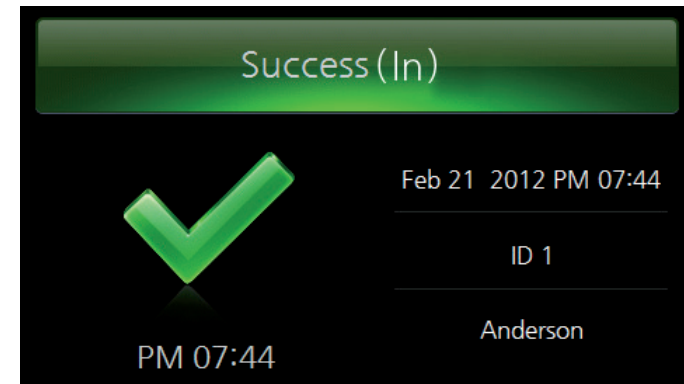

Precautions for Authentication

- If authentication takes too long, slightly move your face.
- Remove any obstacles obstructing your face. The eyes and eyebrows must be exposed.
- Only one person can use the device at a time.
- Do not wear sunglasses when using the device.
- Re-enroll users that have undergone major changes in facial appearance.

Device Operation

Face Authentication Modes

Face

- 1 Scan the face.

Face + Pin

- 1 Scan the face.
- 2 Enter the pin number and press **OK**.

T&A Key > Face

- 1 Press the T&A button.
- 2 Scan the face.

T&A Key > Face + Pin

- 1 Press the T&A button.
- 2 Scan the face.
- 3 Enter the pin number and press **OK**.

Face > T&A Key

- 1 Scan the face.
- 2 Press the T&A button.

Face + Pin > T&A Key

- 1 Scan the face.
- 2 Enter the pin number and press **OK**.
- 3 Press the T&A button.

Card Authentication Modes

Card Only

- 1 Enter the card ID by placing the card on the device.

Card + Pin

- 1 Enter the card ID by placing the card on the device.
- 2 Enter the pin number and press **OK**.

Card + Face

- 1 Enter the card ID by placing the card on the device.
- 2 Scan the face.

Card+ Face/Pin

- 1 Enter the card ID by placing the card on the device.
- 2 Scan the face.
Or, enter the pin number and press **OK**.

Card + Face + Pin

- 1 Enter the card ID by placing the card on the device.
- 2 Scan the face.
- 3 Enter the pin number and press **OK**.

ID Authentication Modes

ID + Pin

- 1 Enter the ID and press **OK**.
- 2 Enter the pin number and press **OK**.

ID + Face

- 1 Enter the ID and press **OK**.
- 2 Scan the face.

ID + Face/Pin

- 1 Enter the ID and press **OK**.
- 2 Scan the face.
Or enter the pin number and press **OK**.

ID + Face + Pin

- 1 Enter the ID and press **OK**.
- 2 Scan the face.
- 3 Enter the pin number and press **OK**.

Using Time and Attendance

- 1 Press one of the T&A keys (F1 ~ F4) or click the T&A button and select an event on screen.

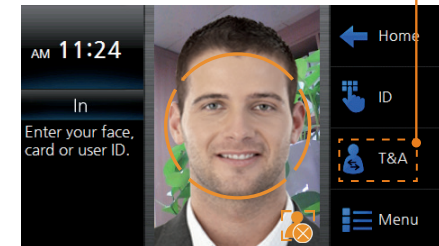

- 2 Perform the authentication process.
- 2 Please refer to 'Authentication Modes(page 51)' for details regarding the face, card and ID authentication processes.

Note

- If the Time and Attendance is set as fixed or manual, the Time and Attendance event does not need to be separately selected. Please refer to 'Time and Attendance Mode(page 34)' for details regarding Time and Attendance.

Device Operation

Checking Time and Attendance

A general user can view their access and attendance records.

- 1 Press **Menu**.

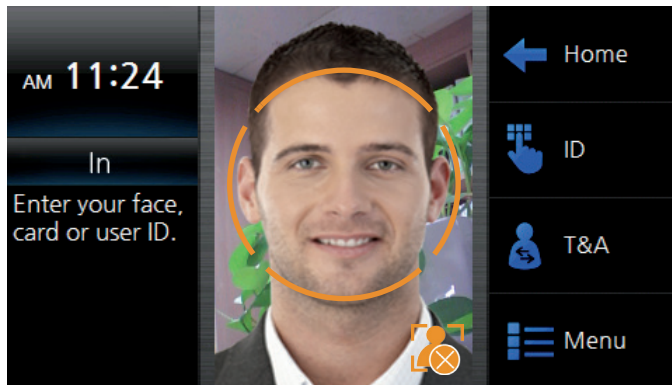

- 2 Successfully authenticate a general user.



Viewing Logs

View, search, or delete all logs.

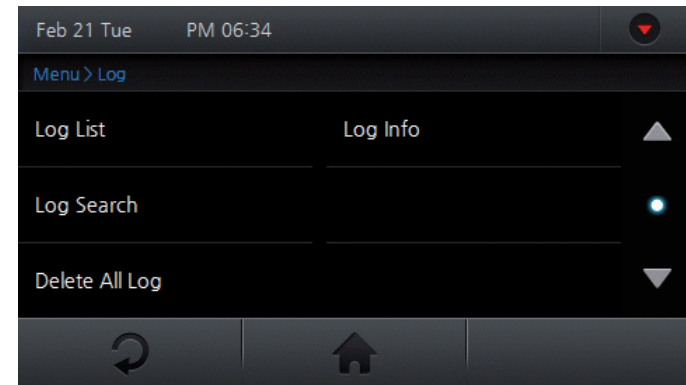

- 1 Go to **Menu > Log**.
- 2 Select the desired option.
- 3 Press to go to the previous screen or to go to the Home screen.

Log List

You can select and view the desired event log.

- 1 Go to **Menu > Log > Log List**.
- 2 View the logs within the device.
- 3 Press to go to the previous screen or to go to the Home screen.

Log Search

Search logs by event, date, time and user ID.

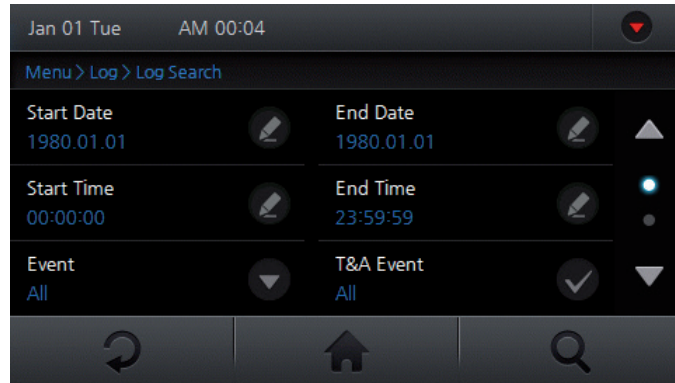

- 1 Go to **Menu > Log > Log Search**.
- 2 Set the search filters and press **OK**.
- 3 Press **Q** to display the search results.
- 4 Press **↶** to go to the previous screen or **🏠** to go to the Home screen.

Delete All Logs

All logs will be deleted from the device's memory.

- 1 Go to **Menu > Log > Delete All Log**.
- 2 Press **Yes** to delete all logs.
Press **No** to cancel the log deletion.

Log Info

View log events stored on the device.

- 1 Go to **Menu > Log > Log Info**.
- 2 Press **OK** to return to the previous screen.

Note

- FaceStation can store up to 1,000,000 logs and 5000 image logs.

Appendix

Specifications

Troubleshooting

FCC Rules

Device Font License

Quality Assurance

Index

Specifications

Product Specifications

System	Max Users	1000 (1:N), 10,000 (1:1)	
	Log Capacity	1,000,000	
	Image Log Capacity	5,000	
	CPU	1.1GHz DSP, 667MHz RISC	
	LCD	4.3" WVGA Touchscreen	
	Memory	4GB Flash + 512MB RAM	
	RF Options	13.56MHz Mifare/DESFire	
	Interfaces	TCP/IP, RS485(2ch), RS232, USB, Wiegand, WiFi	
	Power	12VDC, PoE (Power over Ethernet)	
General	Dimensions	FaceStation (W x H x D)	132 x 165 x 60 mm
		Wall Bracket (W x H)	97 x 107.8 mm (screw joint included)

Electric Specifications

		Min.	Avr.	Max.	Description
Power	Voltage(V)	10.8	12	13.2	Use certified power adapters that meet the specifications.
	Current Consumption (mA)	-	-	850	
	Current Consumption with USB Wireless LAN (mA)	-	-	1350	
Switch Input	VIH(V)	3.5	-	10.0	
	VIL(V)	-	-	2.0	
	Pullup Resistor	-	4.7K	-	
Relay	Voltage	-	-	24 VDC	
	Current	-	0.5 A	1.0 A	

Troubleshooting

Please contact your local dealer/distributor for support or contact Suprema at support@supremainc.com. Please submit the following information and we will coordinate support with your local dealer/distributor.

- Device model
- F/W version of the device
- H/W version of the device
- Detailed information regarding the issue
- Error messages / screenshots, if possible
- Contact information (Company, Name, Telephone, Email)

FCC Rules

Caution

Changes or modifications not expressly approved by the manufacturer responsible for compliance could void the user's authority to operate the equipment.

Warning

This device complies with part 15 of the FCC Rules. Operation is subject to the following two conditions: (1) This device may not cause harmful interference, and (2) this device must accept any interference received, including interference that may cause undesired operation.

Information to User

This equipment has been tested and found to comply with the limit of a Class B digital device, pursuant to Part 15 of the FCC Rules. These limits are designed to provide reasonable protection against harmful interference in a residential installation.

This equipment generates, user and can radiate radio frequency energy and, if not installed and used in accordance with the instructions, may cause harmful interference to radio communications.

However, there is no guarantee that interference will not occur in a particular installation; if this equipment does cause harmful interference to radio or television reception, which can be determined by turning the equipment off and on, the user is encouraged to try to correct the interference by one or more the following measures:

1. Reorient / Relocate the receiving antenna.
2. Increase the separation between the equipment and receiver.
3. Connect the equipment into an outlet on a circuit different from that to which the receiver is connected.
4. Consult the dealer or an experienced radio/TV technician for help.

Device Font License

Copyright (c) 2010, NHN Corporation (<http://www.nhncorp.com>), with Reserved Font Name Nanum, Naver Nanum, NanumGothic, Naver NanumGothic, NanumMyeongjo, Naver NanumMyeongjo.

This Font Software is licensed under the SIL Open Font License, Version 1.1.

This license is copied below, and is also available with a FAQ at: <http://scripts.sil.org/OFL>

SIL OPEN FONT LICENSE

Version 1.1 – 26 February 2007

PREAMBLE

The goals of the Open Font License (OFL) are to stimulate worldwide development of collaborative font projects, to support the font creation efforts of academic and linguistic communities, and to provide a free and open framework in which fonts may be shared and improved in partnership with others.

The OFL allows the licensed fonts to be used, studied, modified and redistributed freely as long as they are not sold by themselves.

The fonts, including any derivative works, can be bundled, embedded, redistributed and/or sold with any software provided that any reserved names are not used by derivative works.

The fonts and derivatives, however, cannot be released under any other type of license.

The requirement for fonts to remain under this license does not apply to any document created using the fonts or their derivatives.

DEFINITIONS

“Font Software” refers to the set of files released by the Copyright Holder(s) under this license and clearly marked as such.

This may include source files, build scripts and documentation.

“Reserved Font Name” refers to any names specified as such after the copyright statement(s).

“Original Version” refers to the collection of Font Software components as distributed by the Copyright Holder(s).

“Modified Version” refers to any derivative made by adding to, deleting, or substituting in part or as a whole, any of the components of the Original Version, by changing formats or by porting the Font Software to a new environment.

“Author” refers to any designer, engineer, programmer, technical writer or other person who contributed to the Font Software.

PERMISSION & CONDITIONS

Permission is hereby granted, free of charge, to any person obtaining a copy of the Font Software, to use, study, copy, merge, embed, modify, redistribute, and sell modified and unmodified copies of the Font Software, subject to the following conditions:

- 1) Neither the Font Software nor any of its individual components, in Original or Modified Versions, may be sold by itself.
- 2) Original or Modified Versions of the Font Software may be bundled, redistributed and/or sold with any software, provided that each copy contains the above copyright notice and this license. These can be included either as stand-alone text files, human-readable headers or in the appropriate machine-readable metadata fields within text or binary files as long as those fields can be easily viewed by the user.
- 3) No Modified Version of the Font Software may use the Reserved Font Name(s) unless explicit written permission is granted by the corresponding Copyright Holder. This restriction only applies to the primary font name as presented to the users.
- 4) The name(s) of the Copyright Holder(s) or the Author(s) of the Font Software shall not be used to promote, endorse or advertise any Modified Version, except to acknowledge the contribution(s) of the Copyright Holder(s) and the Author(s) or with their explicit written permission.
- 5) The Font Software, modified or unmodified, in part or in whole, must be distributed entirely under this license, and must not be distributed under any other license. The requirement for fonts to remain under this license does not apply to any document created using the Font Software.

TERMINATION

This license becomes null and void if any of the above conditions are not met.

DISCLAIMER

THE FONT SOFTWARE IS PROVIDED “AS IS”, WITHOUT WARRANTY OF ANY KIND, EXPRESS OR IMPLIED, INCLUDING BUT NOT LIMITED TO ANY WARRANTIES OF MERCHANTABILITY, FITNESS FOR A PARTICULAR PURPOSE AND NONINFRINGEMENT OF COPYRIGHT, PATENT, TRADEMARK, OR OTHER RIGHT. IN NO EVENT SHALL THE COPYRIGHT HOLDER BE LIABLE FOR ANY CLAIM, DAMAGES OR OTHER LIABILITY, INCLUDING ANY GENERAL, SPECIAL, INDIRECT, INCIDENTAL, OR CONSEQUENTIAL DAMAGES, WHETHER IN AN ACTION OF CONTRACT, TORT OR OTHERWISE, ARISING FROM, OUT OF THE USE OR INABILITY TO USE THE FONT SOFTWARE OR FROM OTHER DEALINGS IN THE FONT SOFTWARE.

Quality Assurance

Warranty

Suprema warrants the performance of the product specified in the specifications within the limitations set forth for a warranty period of one year from the date of delivery to the purchaser. If the purchaser claims any defects covered in this warranty in writing within the warranty period, then Suprema will repair or replace and deliver the defective product that is returned within the warranty period; provided that the purchaser shall be responsible for any transportation cost (including insurance for overseas shipping). This warranty does not apply to: (1) damage caused by strong external physical impact, overcurrent, misuse, abuse, or negligence; (2) damage to the product that has been improperly repaired, remodeled, or modified without the written permission of the provider; or (3) damage to the product that has been installed or used contrary to the manual provided by Suprema.

Claims for any defects must be submitted to Suprema in writing by using the Return Material Authorization Report provided by Suprema within 30 days of the finding of the defect or within 1 year from the date of delivery. The Return Material Authorization Report must include the detailed information, model number, invoice number, and serial number of the defective product. A product without the return authorization number issued by Suprema is not considered to be eligible for the warranty; all defects must be reproducible.

Excluding the above-mentioned warranties and remedies, this product is provided as-is without any expressed or implied warranties regarding product warranty, commercial viability, or availability for a particular purpose.

Disclaimer

The information in this document is provided in connection with Suprema products. The license is granted only for products covered by Suprema's Terms and Conditions of Sale. No license, express or implied, by estoppels or otherwise, to any intellectual property rights is granted by this document. Suprema assumes no liability whatsoever and Suprema disclaims any express or implied warranty, relating to sale and/or use of Suprema products, including liability or warranties relating to fitness for a particular purpose, merchantability, or infringement of any patent, copyright, or other intellectual property right. Suprema products are not intended for use in medical, life saving, or life sustaining applications or other applications in which the failure of the Suprema product could create a situation where personal injury or death may occur. Should Buyer purchase or use Suprema products for any such unintended or unauthorized application, Buyer shall indemnify and hold Suprema and its officers, employees, subsidiaries, affiliates, and distributors harmless against all claims, costs, damages, expenses, and reasonable attorney fees arising out of, directly or indirectly, any claim of personal injury or death associated with such unintended or unauthorized use, even if such claim alleges that Suprema was negligent regarding the design or manufacture of the part. Suprema reserves the right to make changes to specifications and product descriptions at any time without notice to improve reliability, function, or design. Designers must not rely on the absence or characteristics of any features or instructions marked "reserved" or "undefined." Supreme reserves these for future definition and shall have no responsibility whatsoever for conflicts or incompatibilities arising from future changes to them.

Index

- A
- Analogue Video Phone Connection 25
 - Authentication Modes 51
- B
- BS VideoPhone Setting 37
- C
- Card Authentication Modes 52
 - Checking Device Information 38
 - Checking Memory Status 38
 - Checking Time and Attendance 54
 - Checking User Capacity 50
- D
- Delete All Logs 55
 - Deleting a User 49
 - Device Reset 39
 - Device Status Screen 44
 - Display and Sound Settings 40
- E
- Electric Specifications 57
 - Ethernet Connections 19
- F
- Face Authentication Mode 32
 - Face Authentication Modes 52
 - Face Authentication Procedure 51
 - Face Authentication Screen 43
 - FaceStation Menu Tree 27
 - Factory Default 39
- H
- Home Screen 43
- I
- ID Authentication Mode 33
 - ID Authentication Modes 53
 - Input Connection 23
 - Installation Location 14
- L
- Log Info 55
 - Log List 54
 - Log Search 55
- M
- Mini USB Connection 24
 - Modifying User Information 48, 49
- O
- Optional Accessories 9
- P
- Power Connection 18
 - Product Description 10
 - Product Specifications 57
- Q
- Quality Assurance 60
- R
- Recommended Installation Height 14
 - Relay Connections 22
 - RS232 Connection 21
 - RS485 Connections 20
- S
- Searching for a User 50
 - Setting Door Control 35
 - Setting Face Authentication Settings 35
 - Setting General Operational Parameters 33
 - Setting Interphone 36
 - Setting Serial Communication 29
 - Setting Server 29
 - Setting TCP/IP 28
 - Setting USB 30
 - Setting WLAN (Only for wireless models) 31
- T
- Time and Attendance Mode 34
 - TouchScreen Calibration 39
- U
- USB Connection 25
 - Using Time and Attendance 53
 - Using USB Memory Device 30
- V
- VoIP Setting 37
- W
- Wiegand Connections 23
 - Wireless LAN Connection 18



Suprema Inc.

16F Parkview Tower, 6 Jeongja, Bundang, Seongnam, Gyeonggi, 463-863 Korea

Tel: +82-31-783-4502 | Fax: +82-31-783-4503

Email: sales@supremainc.com | Homepage: www.supremainc.com